

配置図 1:200

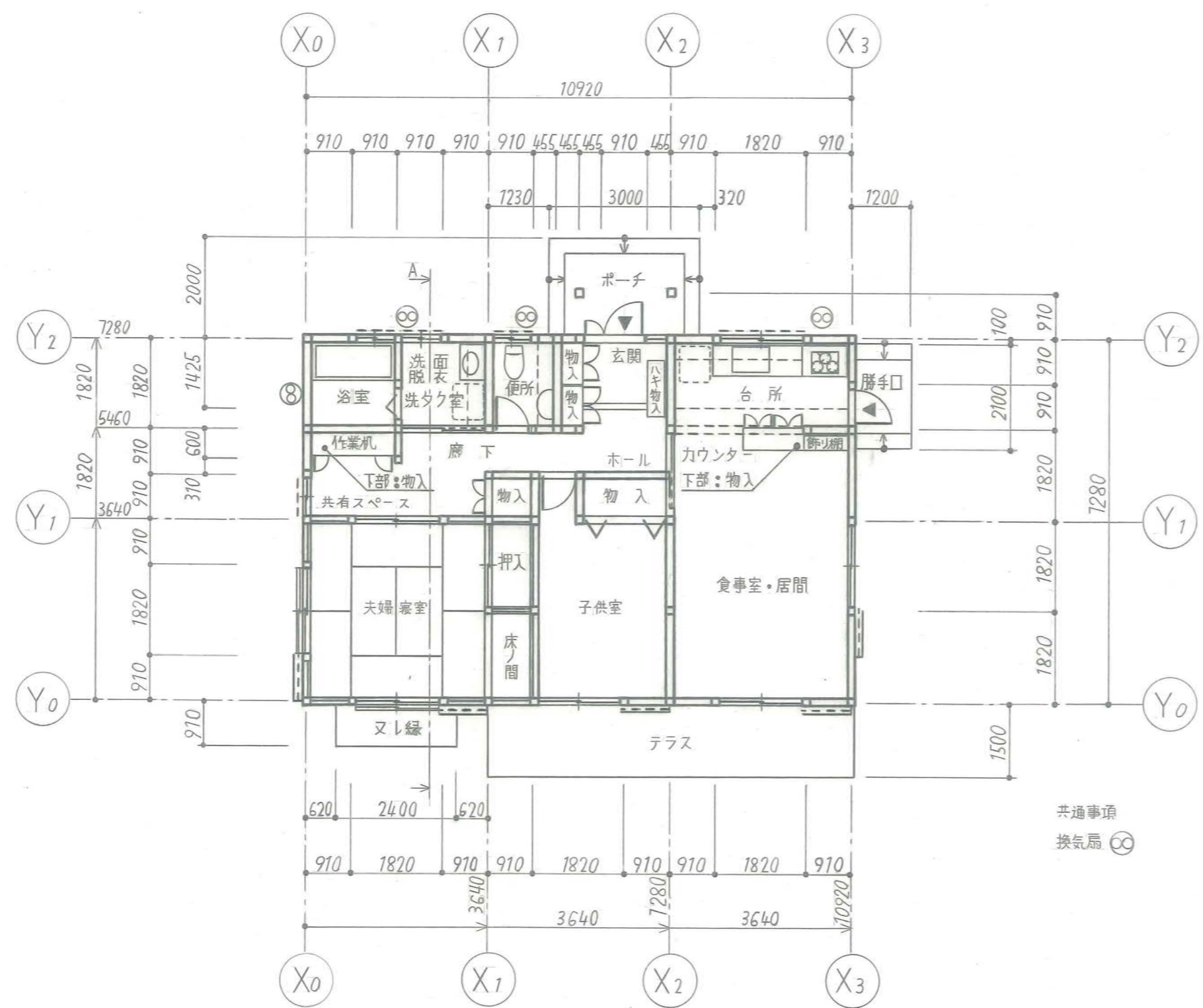

平面図 1:100

共通事項
換気扇

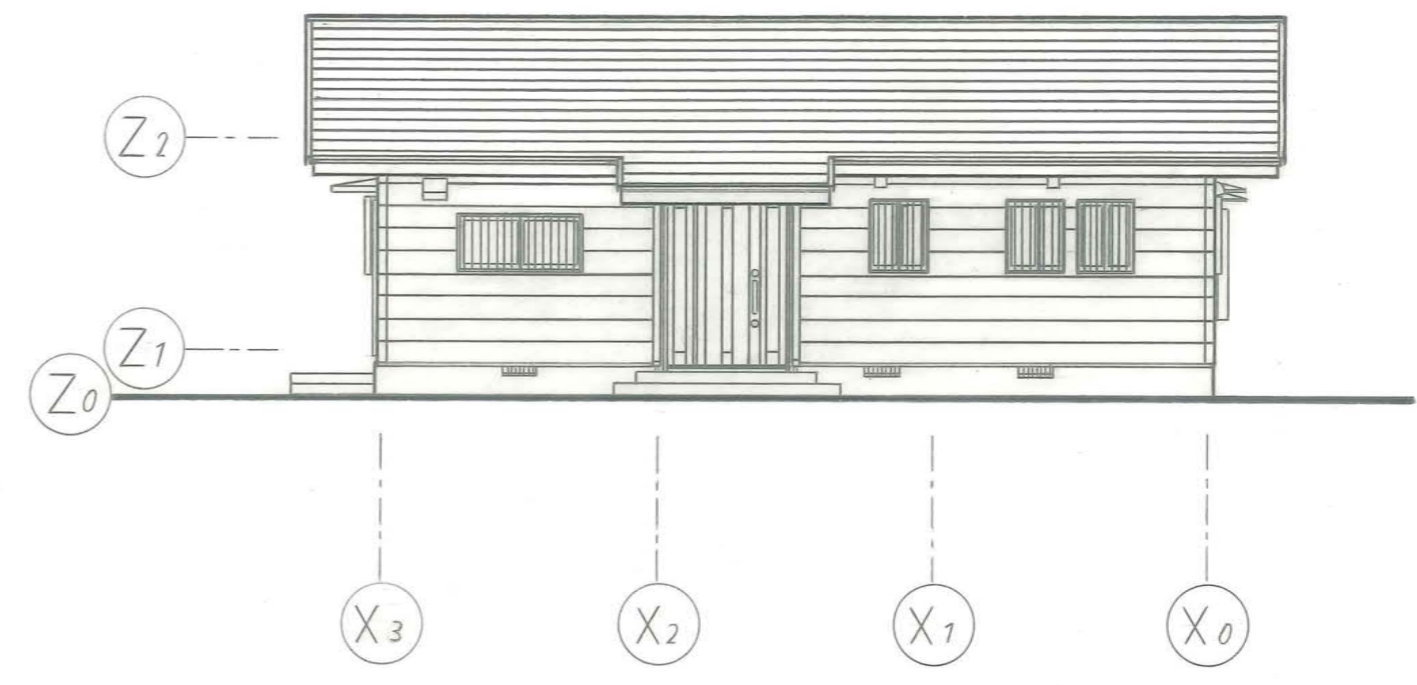

北立面図 1:100

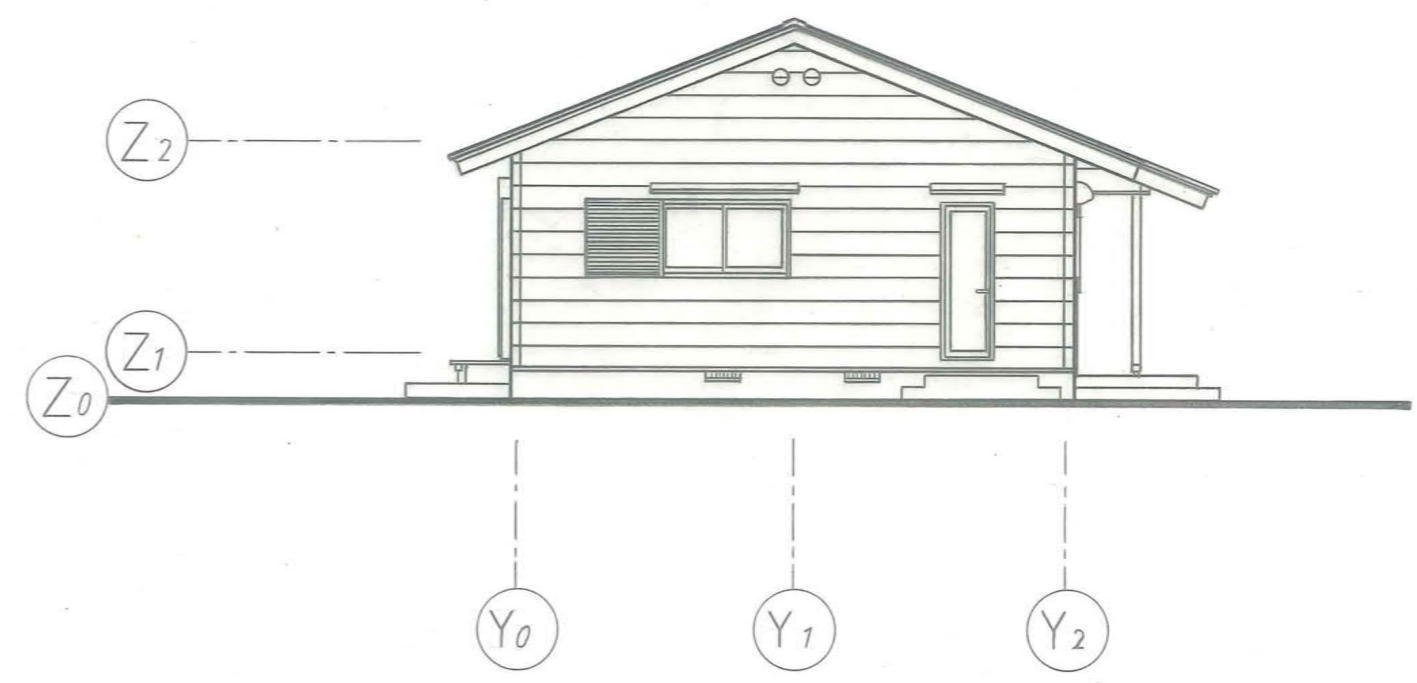

東立面図 1:100

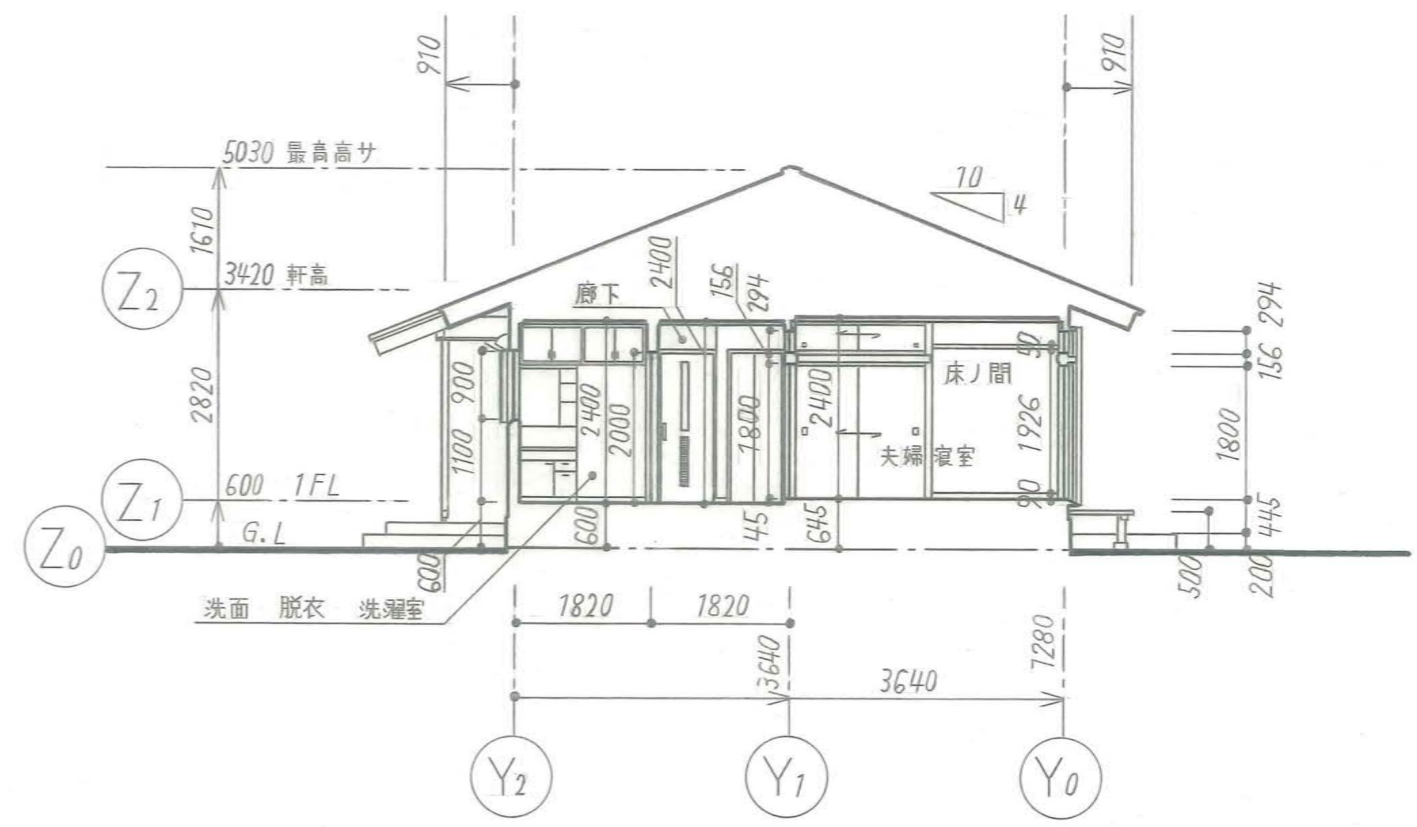

A-A 断面図 1:100

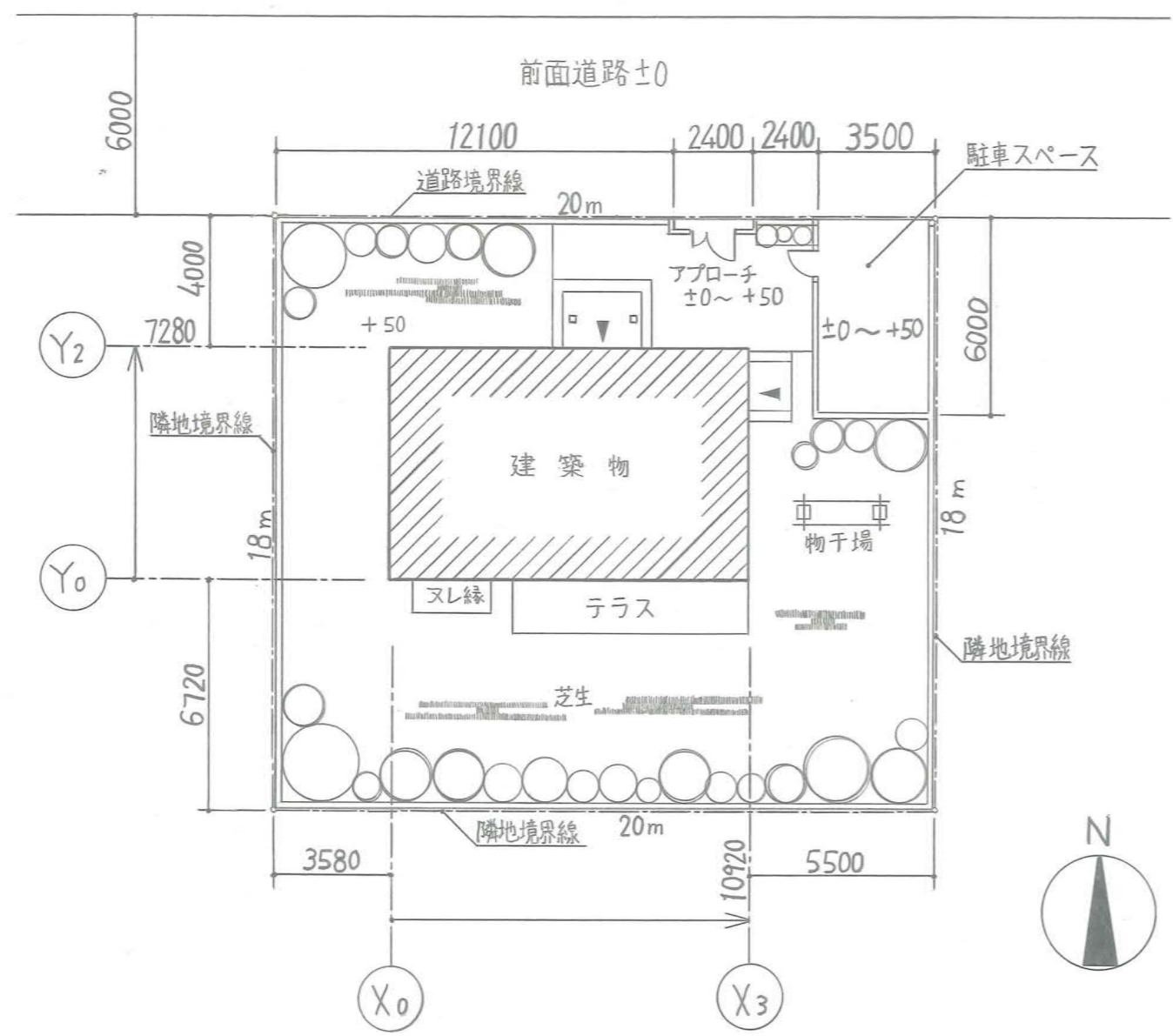

配置図 1:200

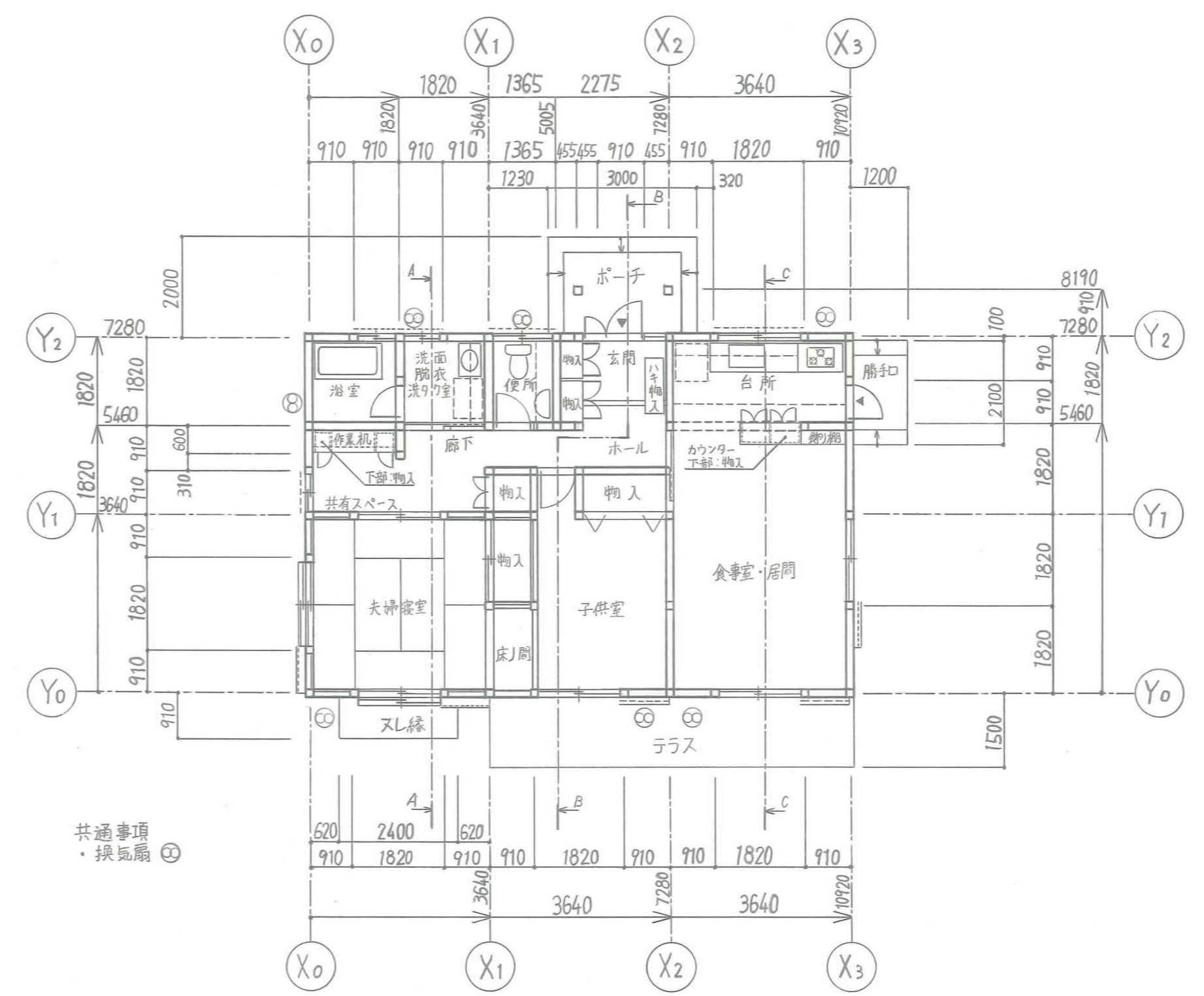

平面図 1:100

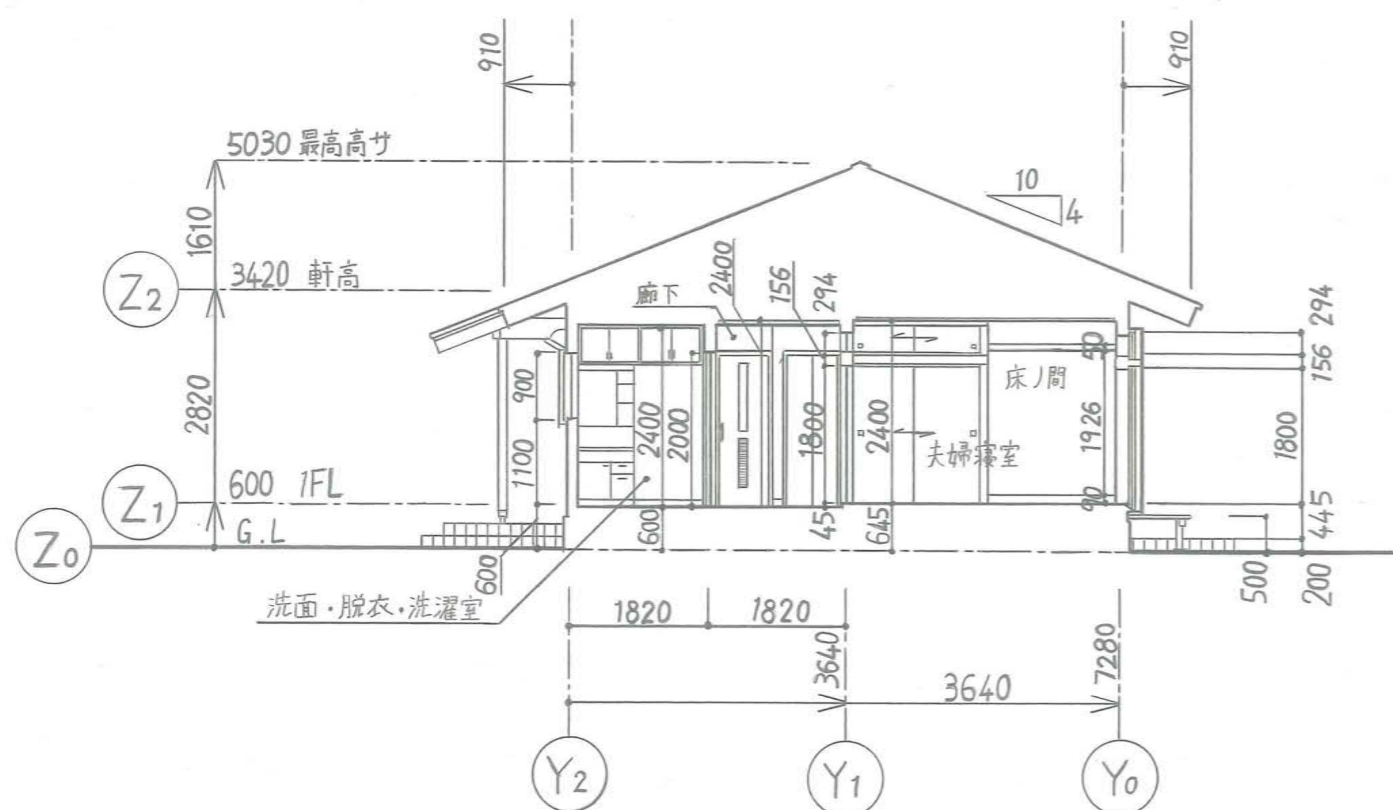

A-A断面図

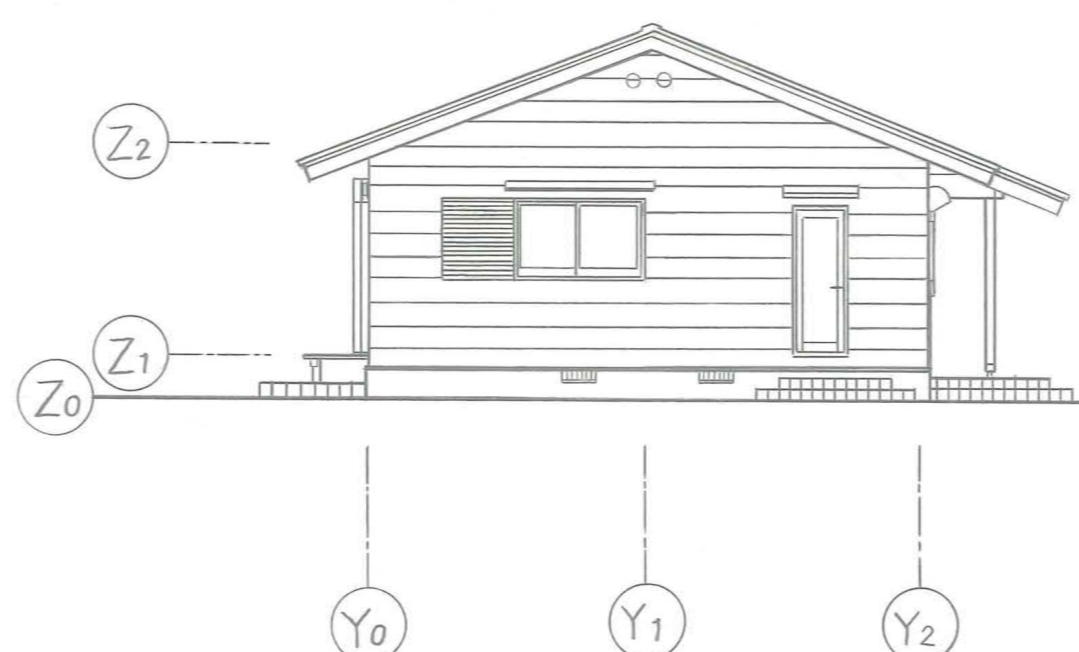

東立面図



北立面図

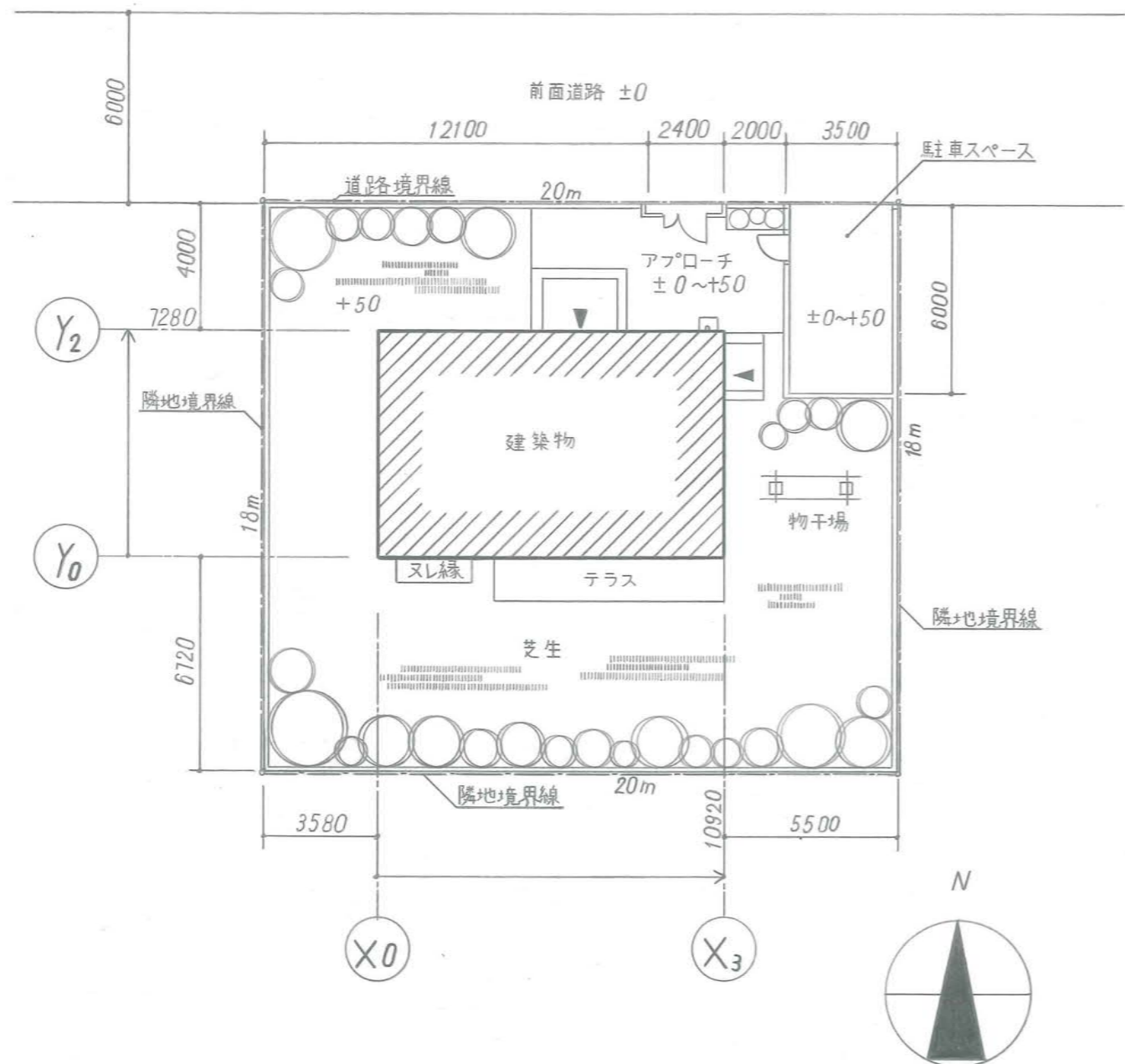

配置図 1:200

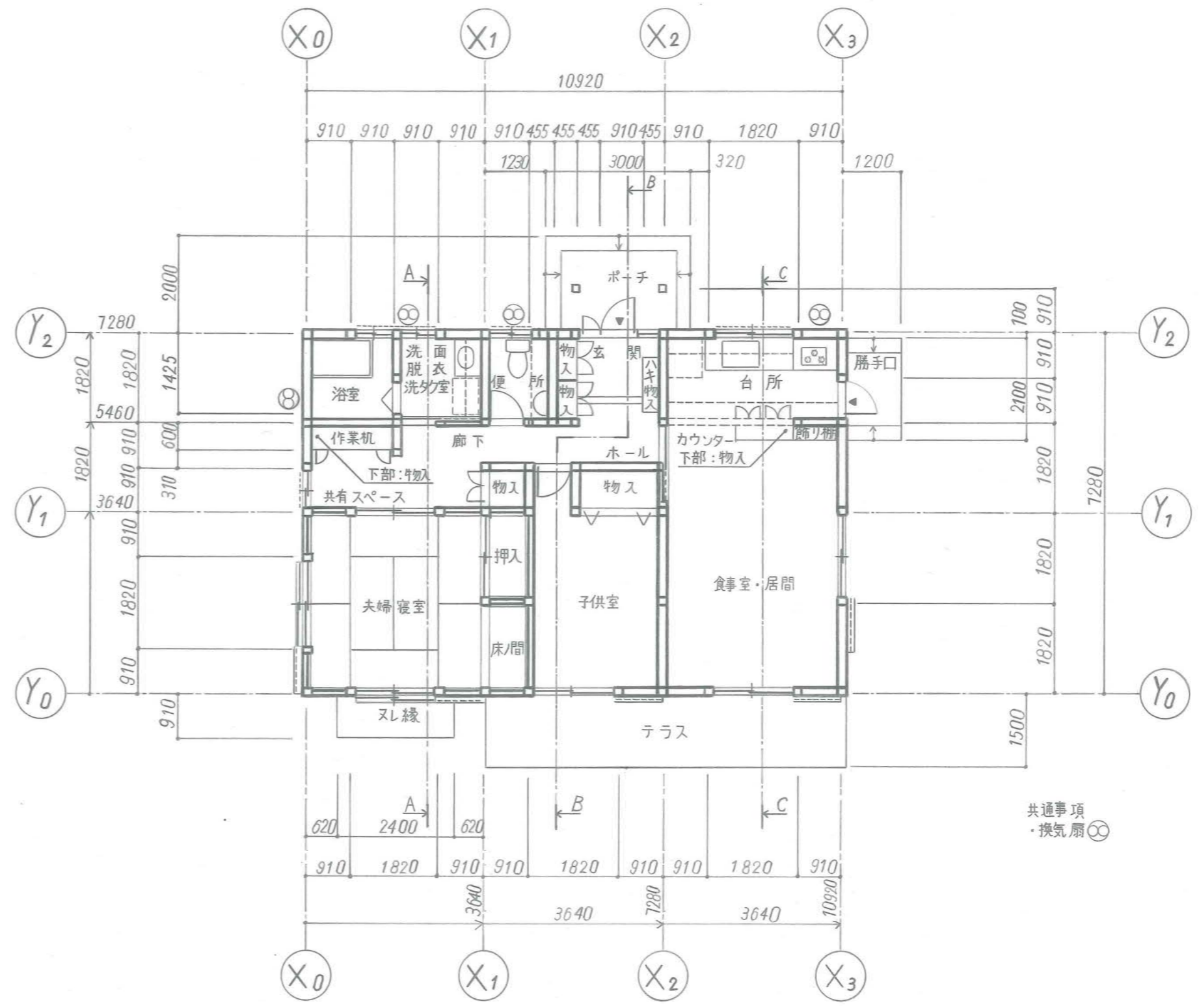

平面図 1:100

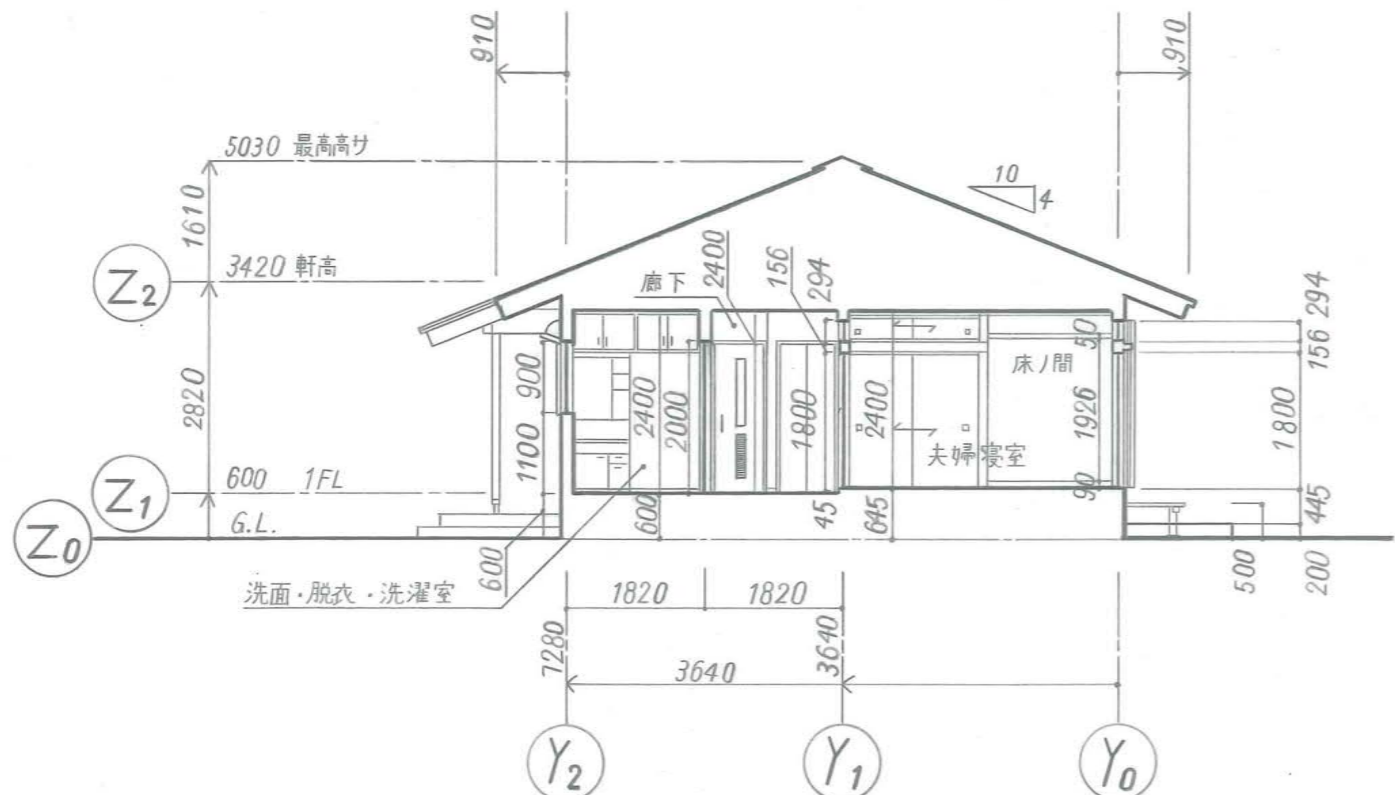

A-A断面図

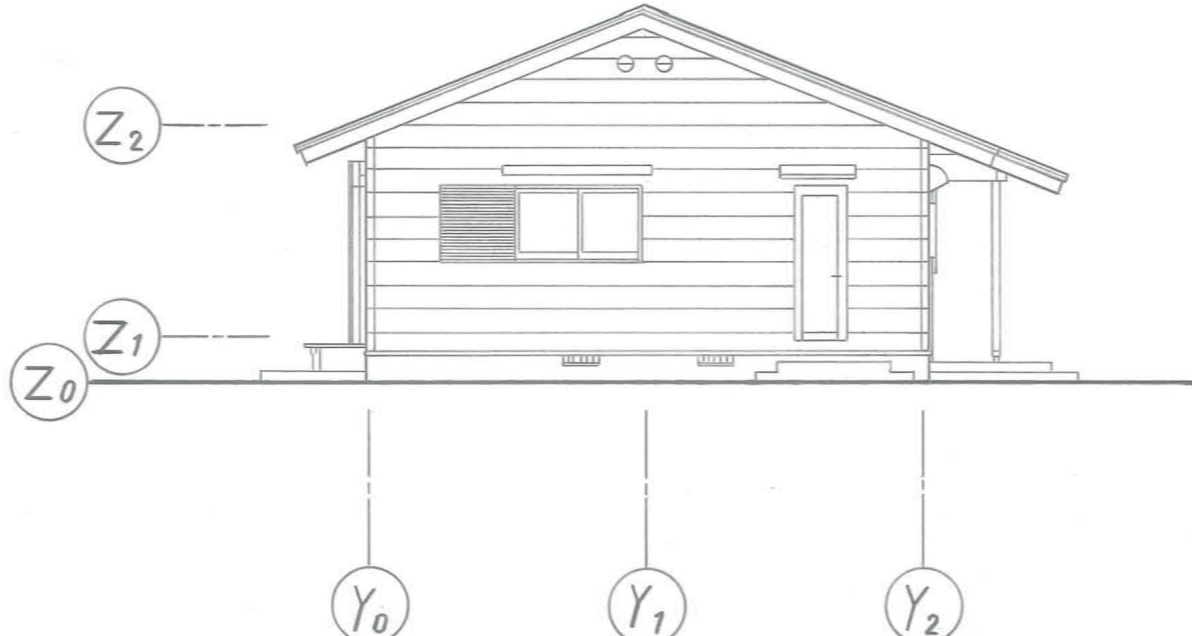

東立面図



北立面図

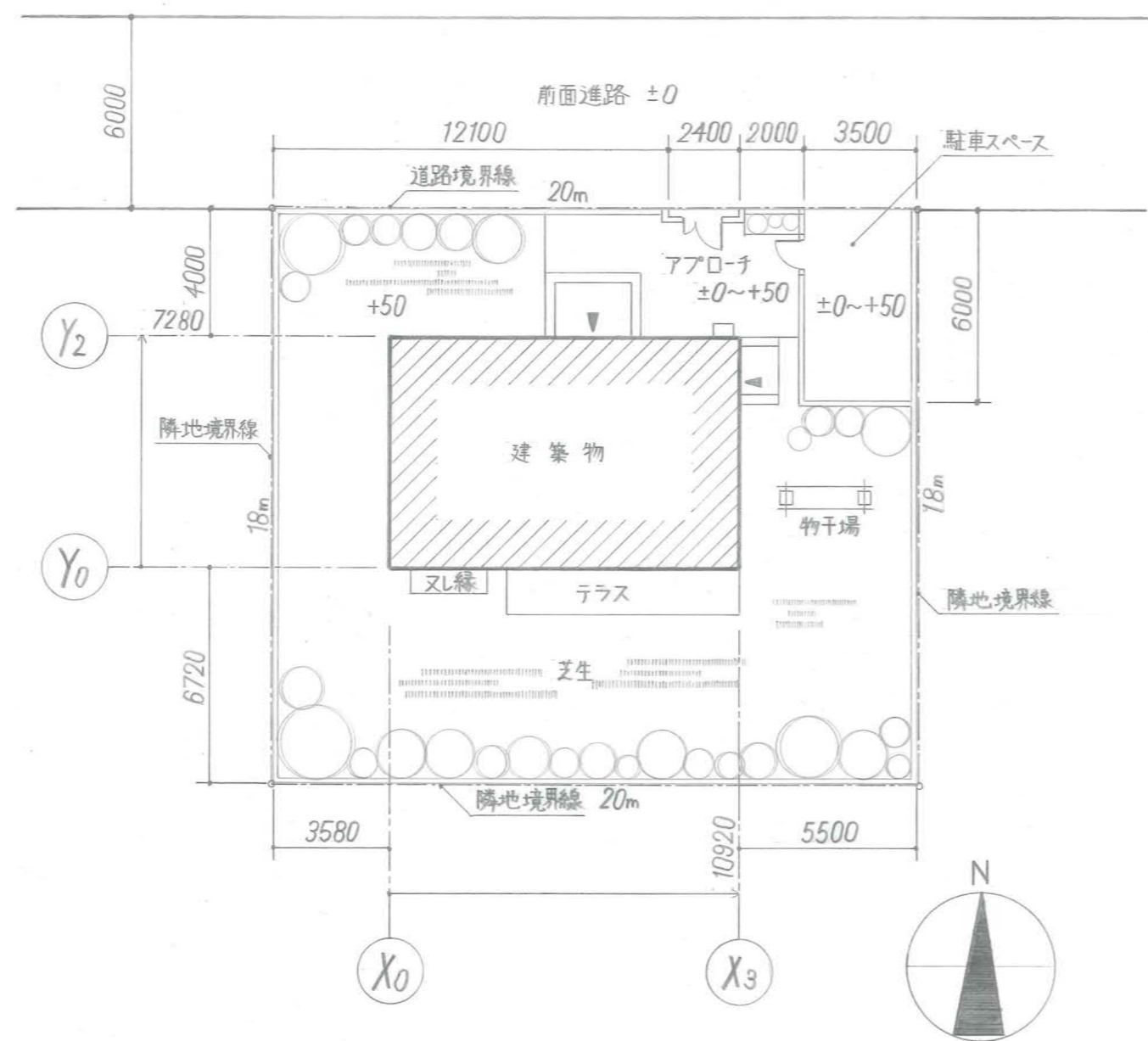

配置図 1:200

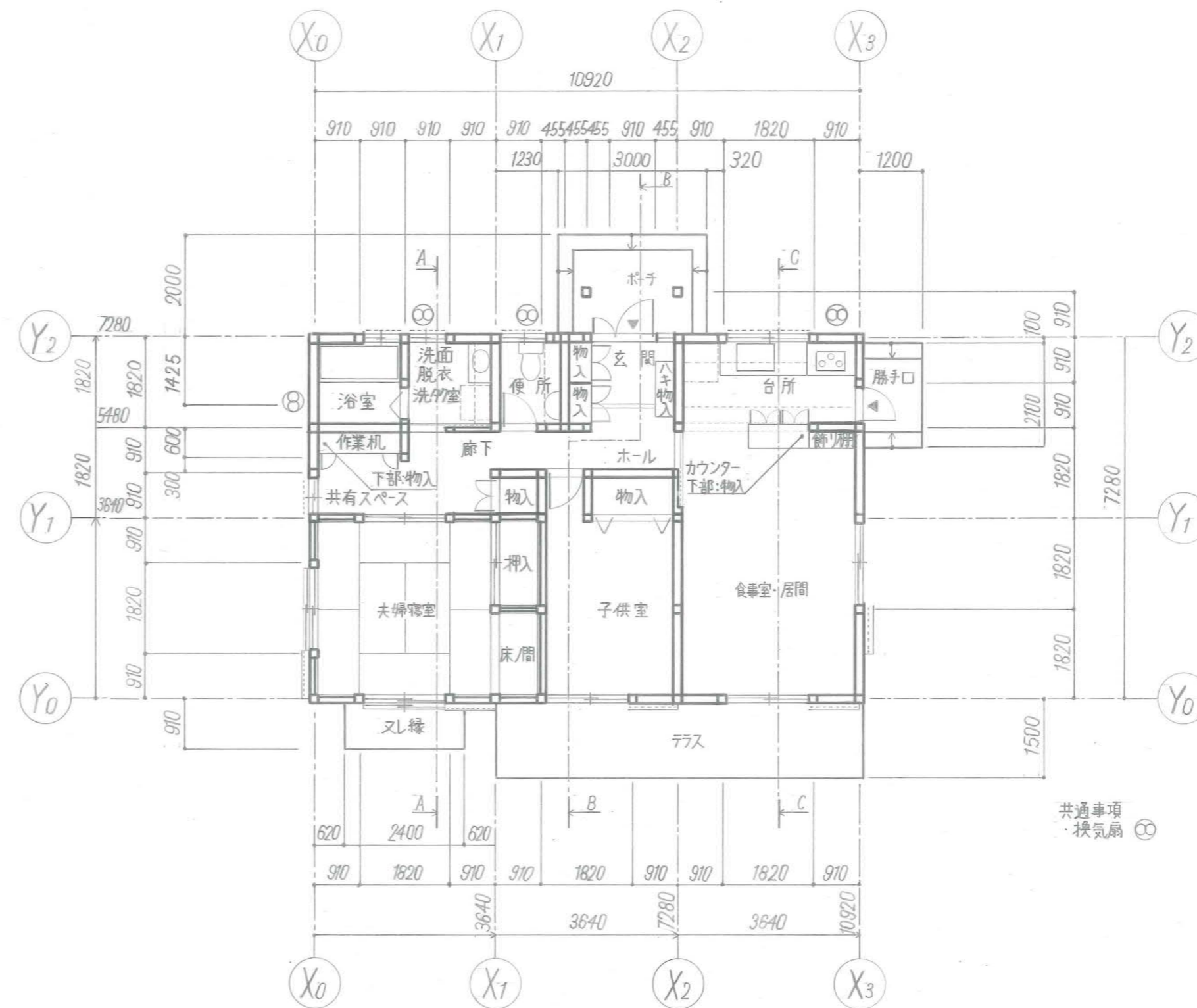

平面図 1:100

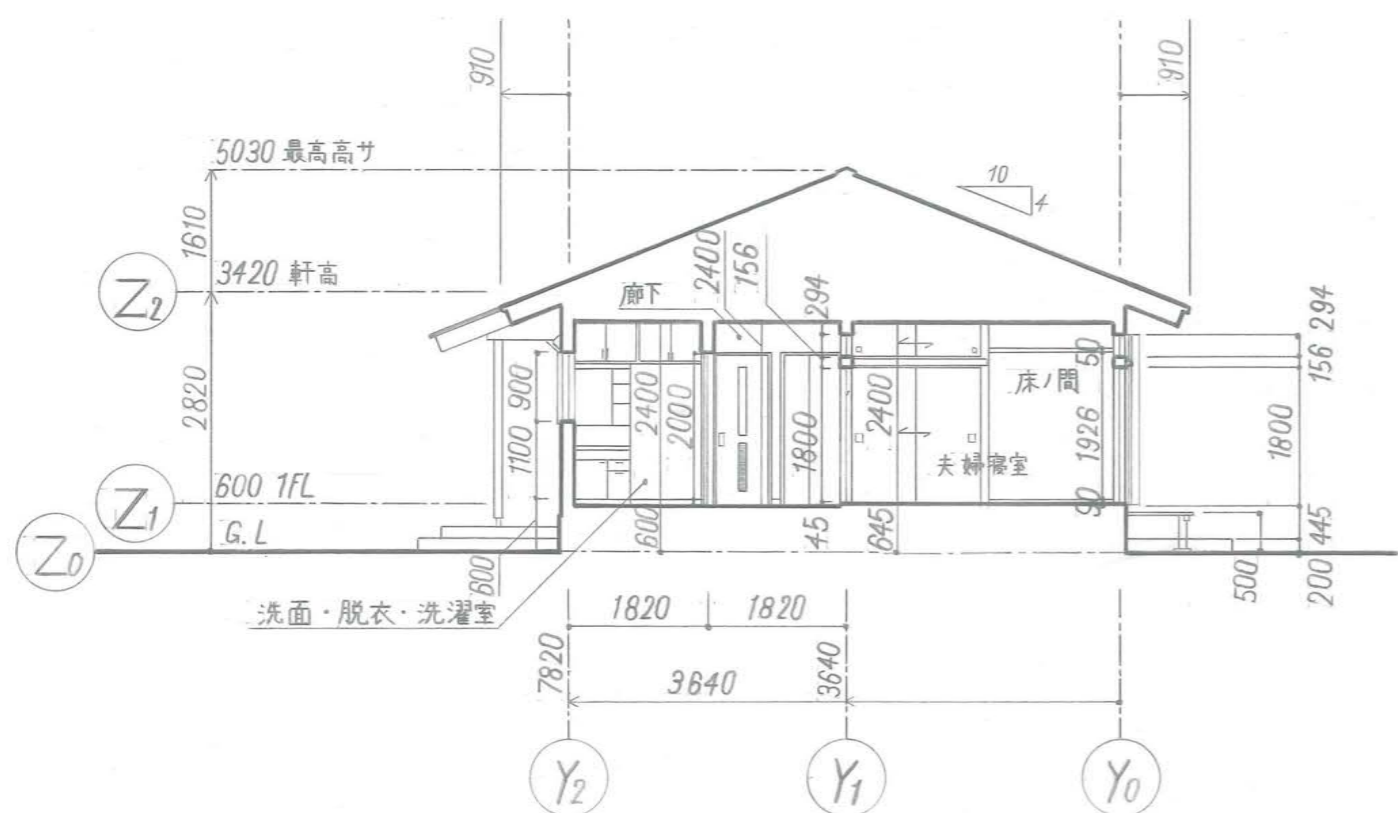

A-A断面図

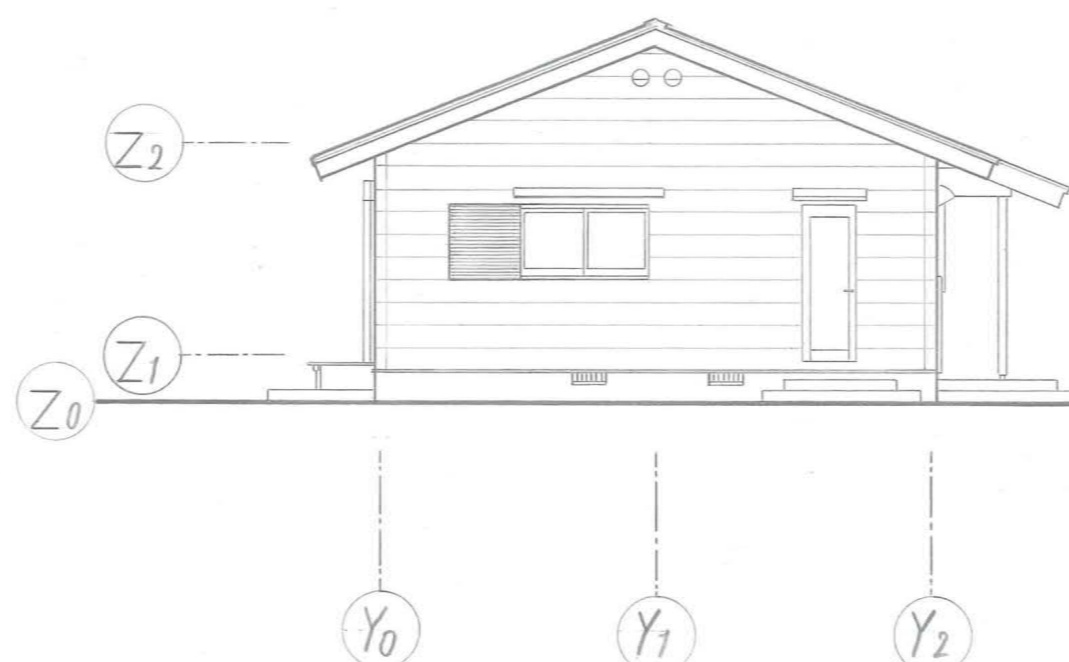

東立面図



北立面図

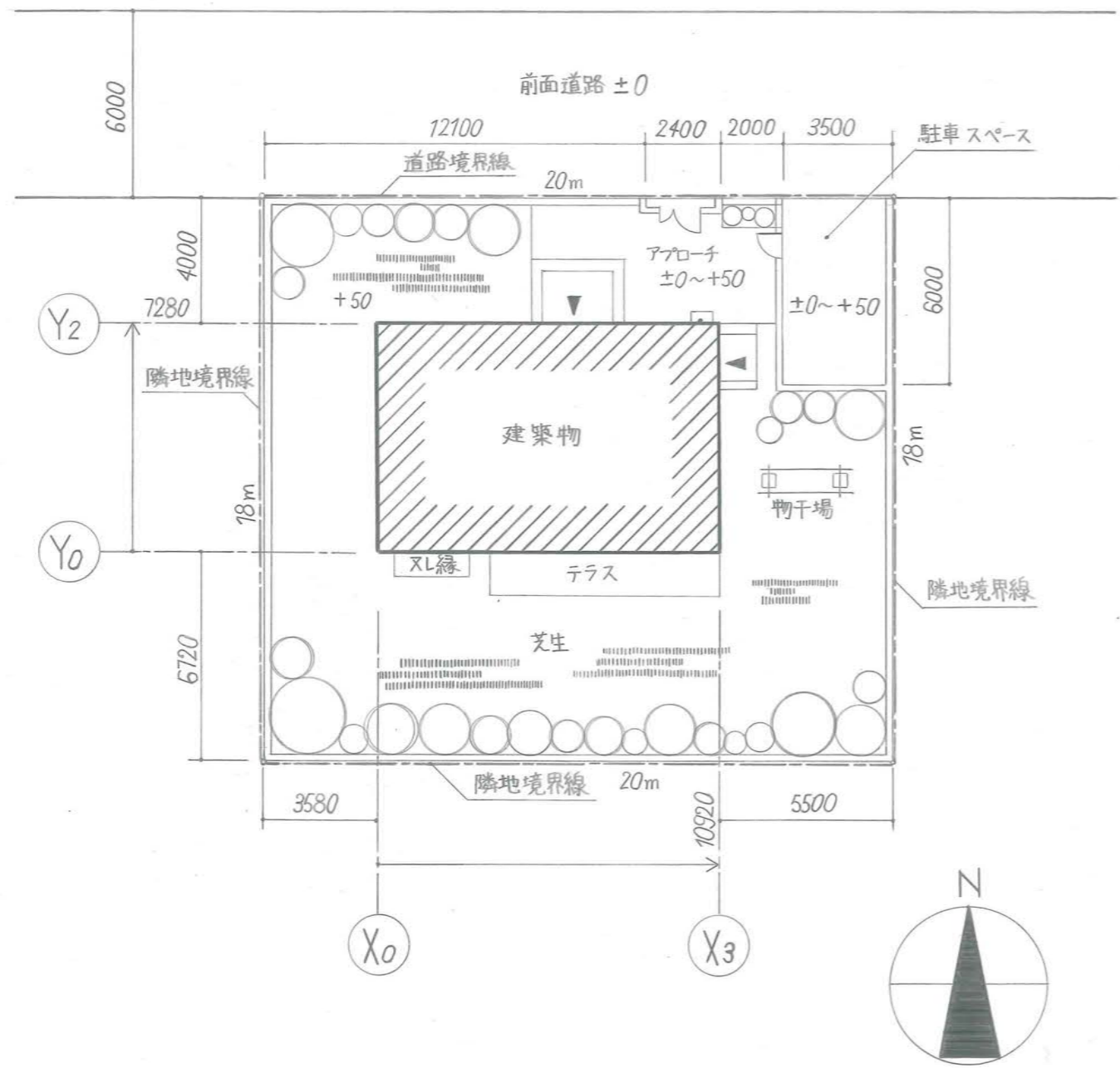

配置図 1:200

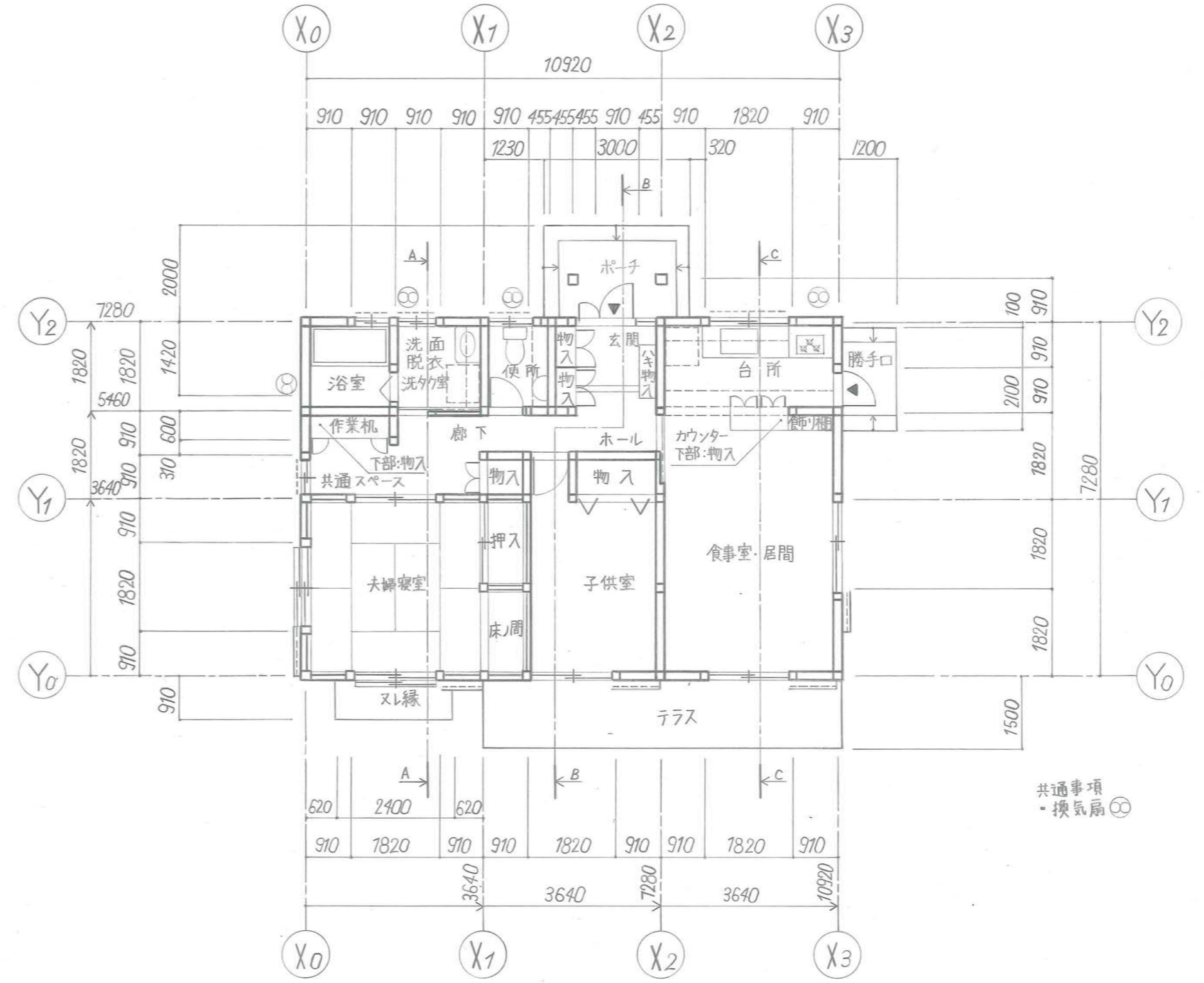

平面図 1:100

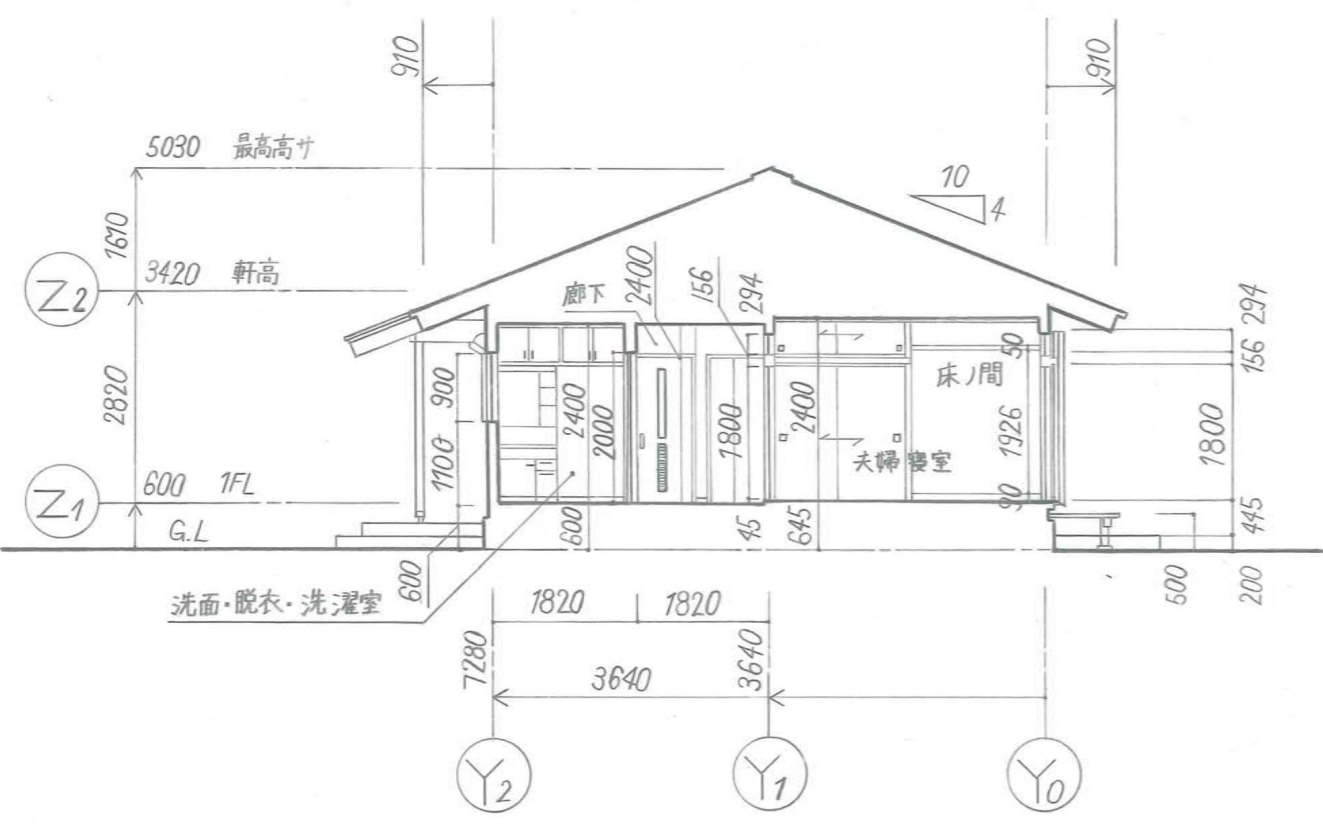

A-A断面図

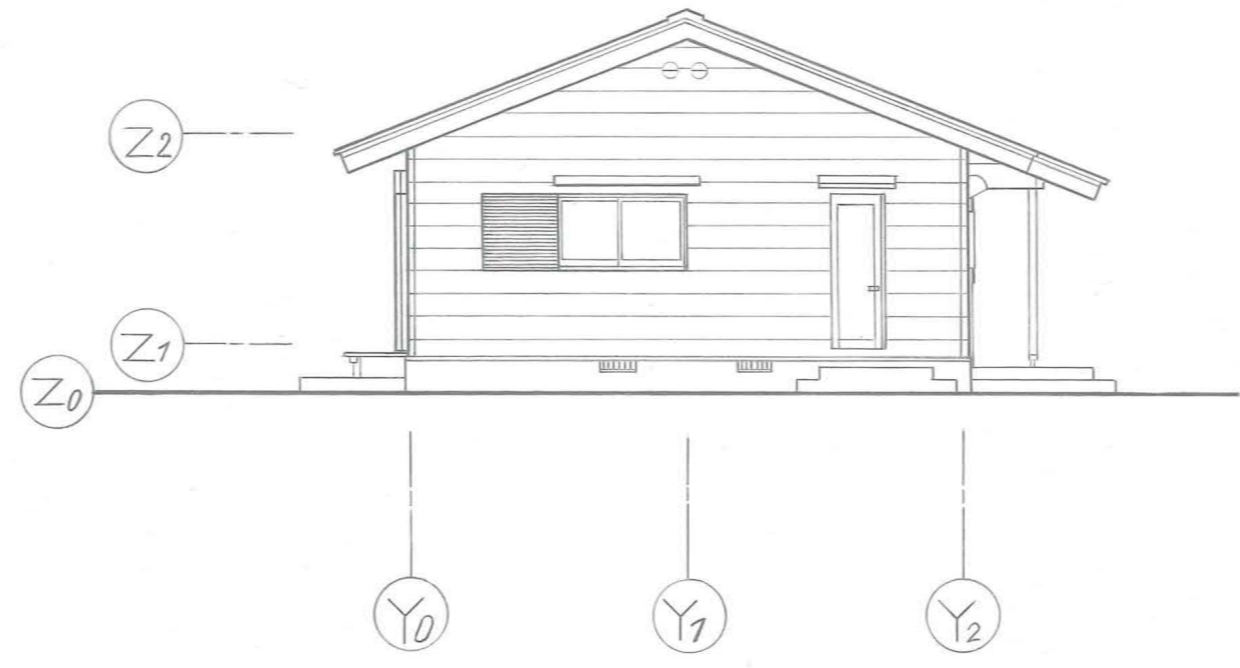

東立面図



北立面図

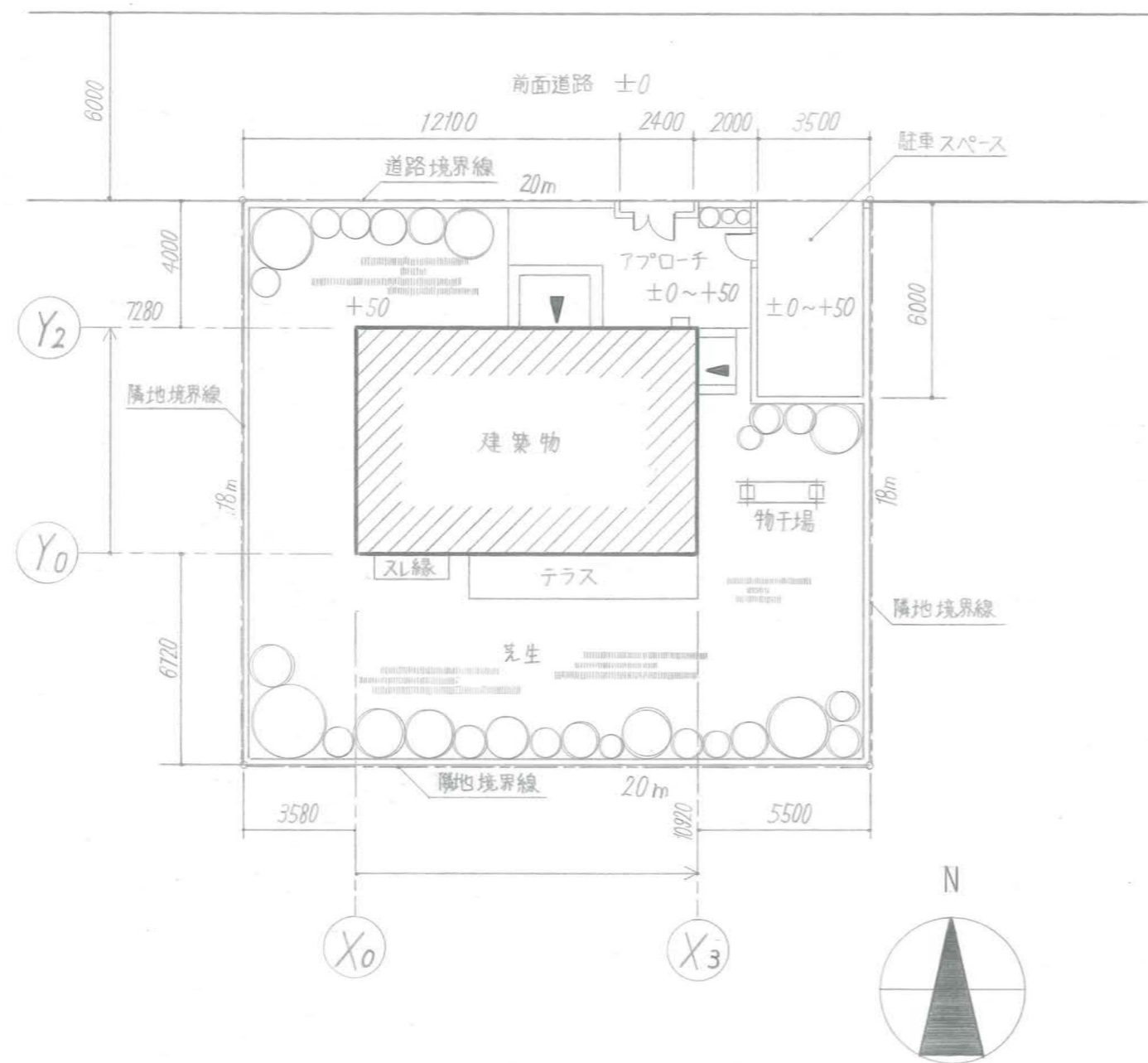

配置図 1:200

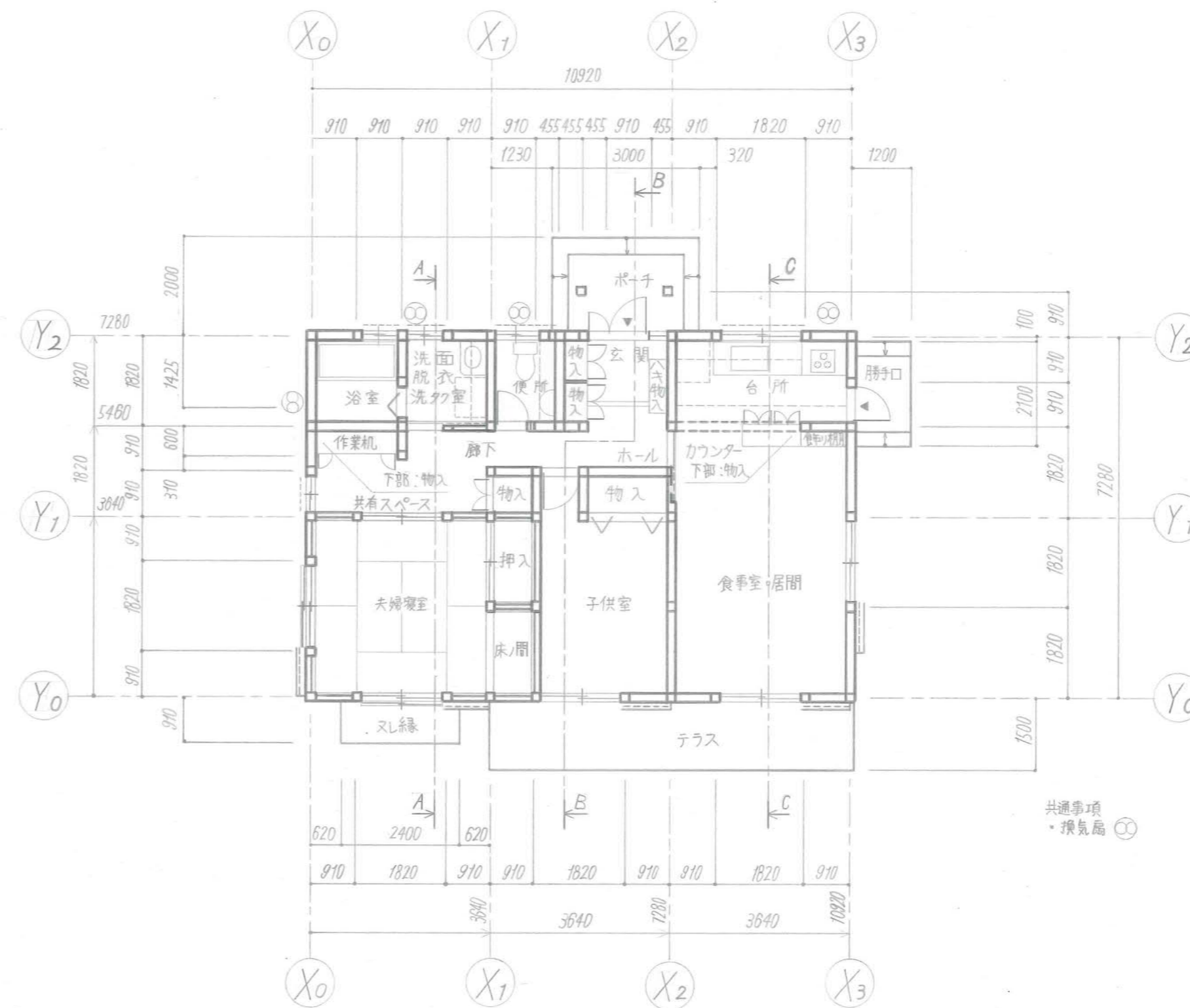

平面図 1:100

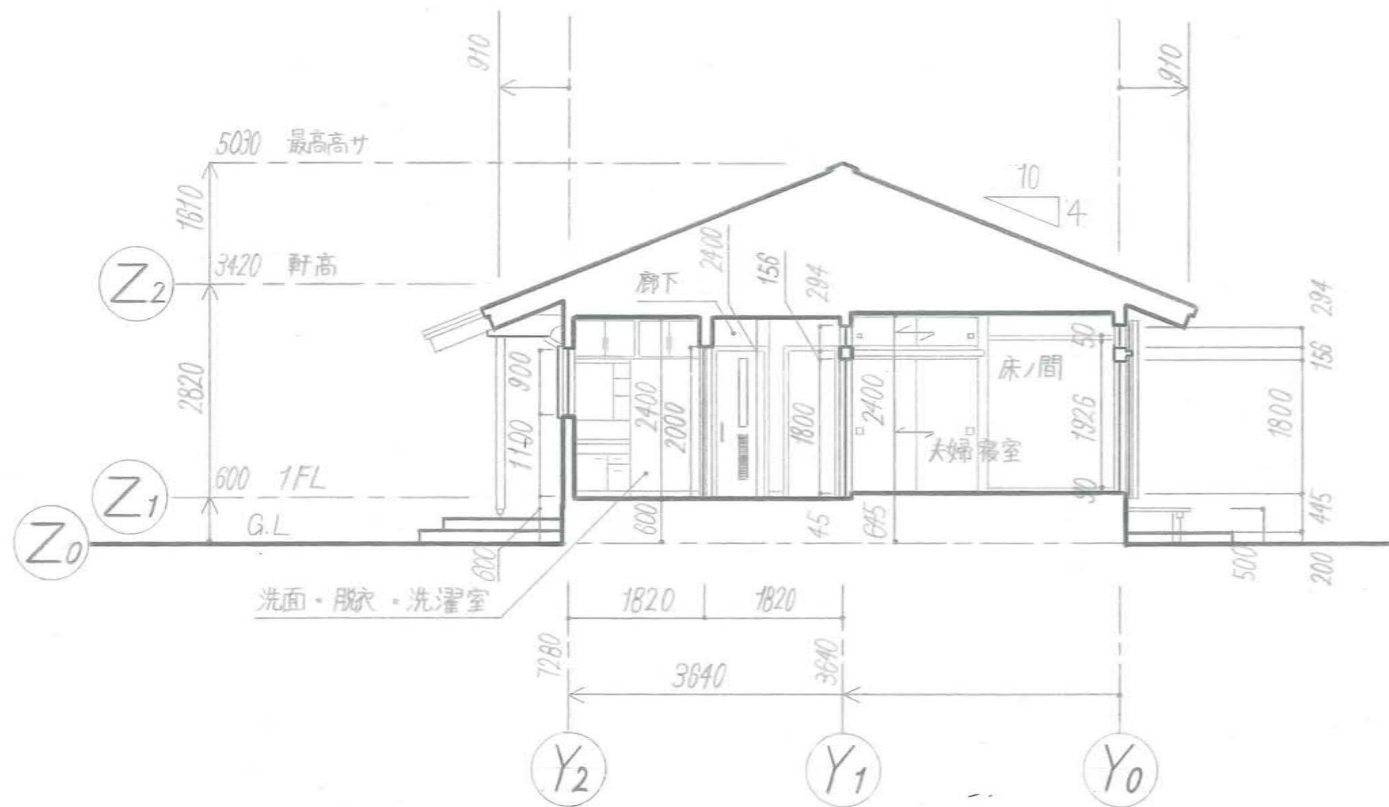

A-A断面図

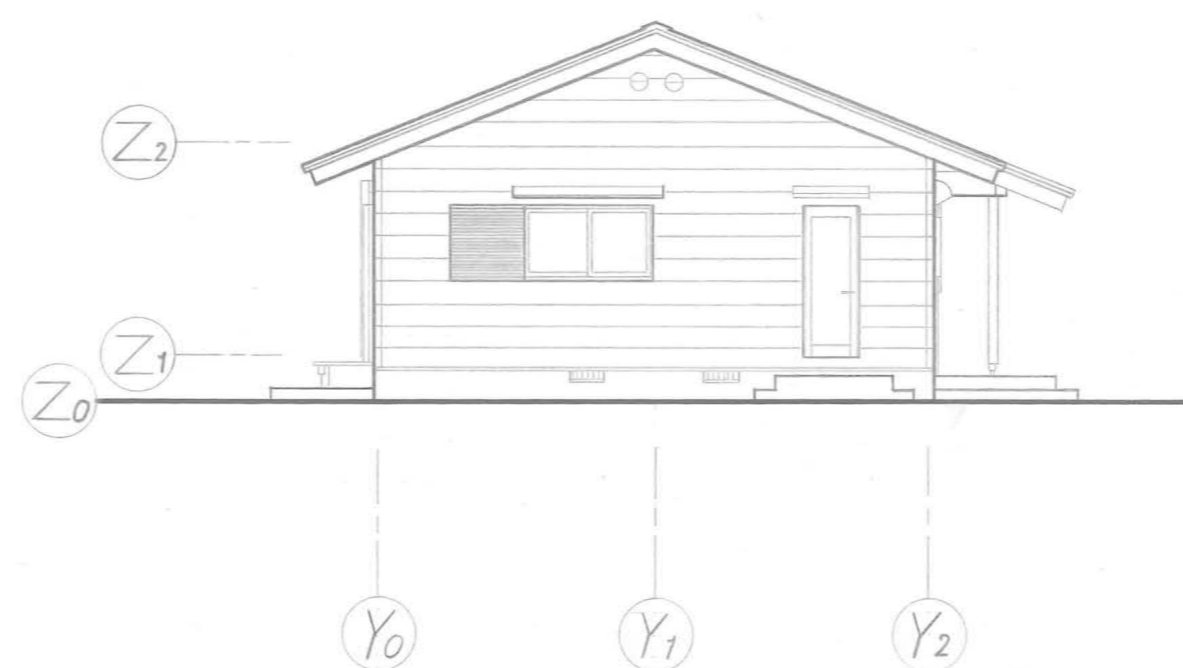

東立面図



北立面図

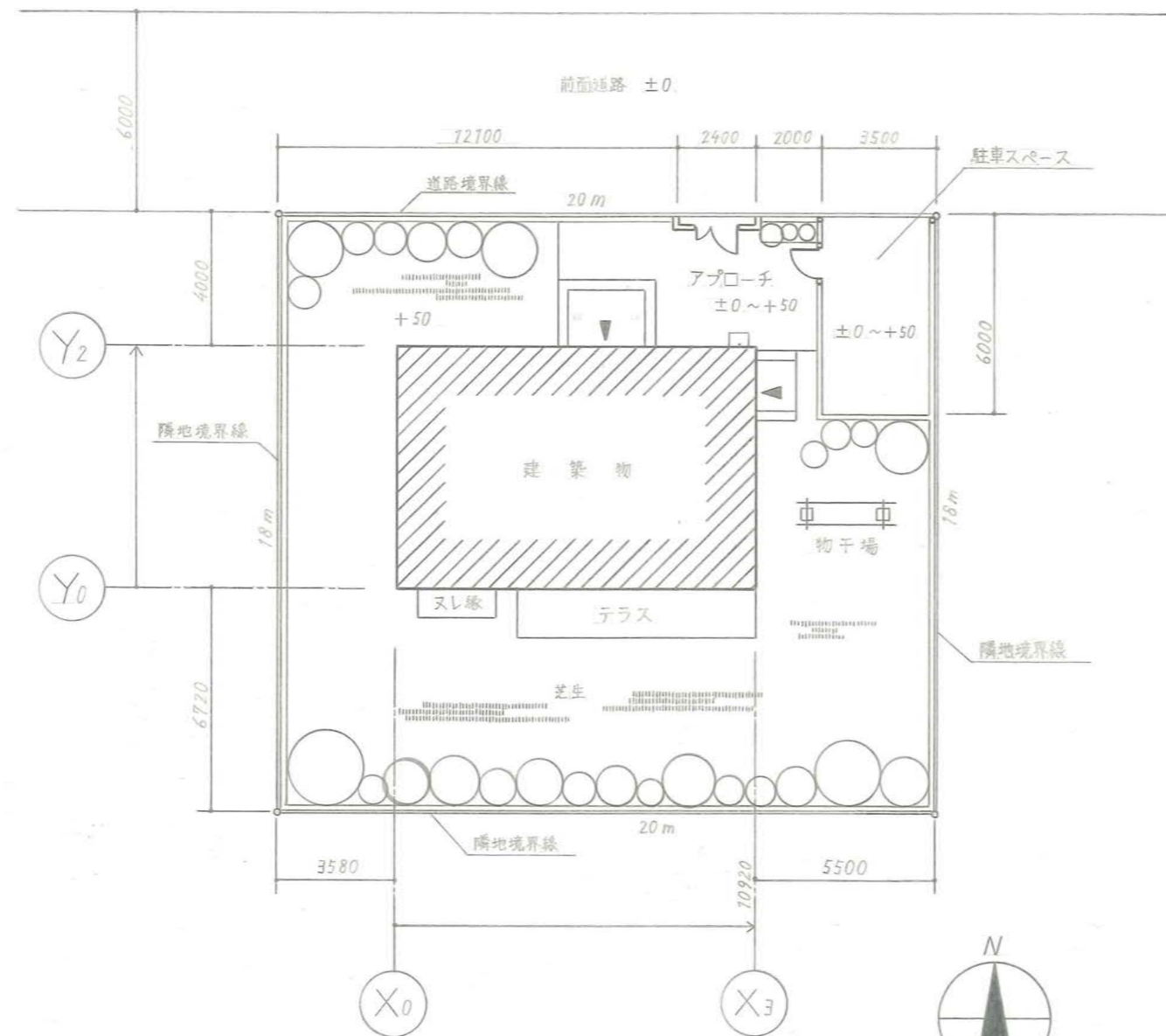

配置図 1:200

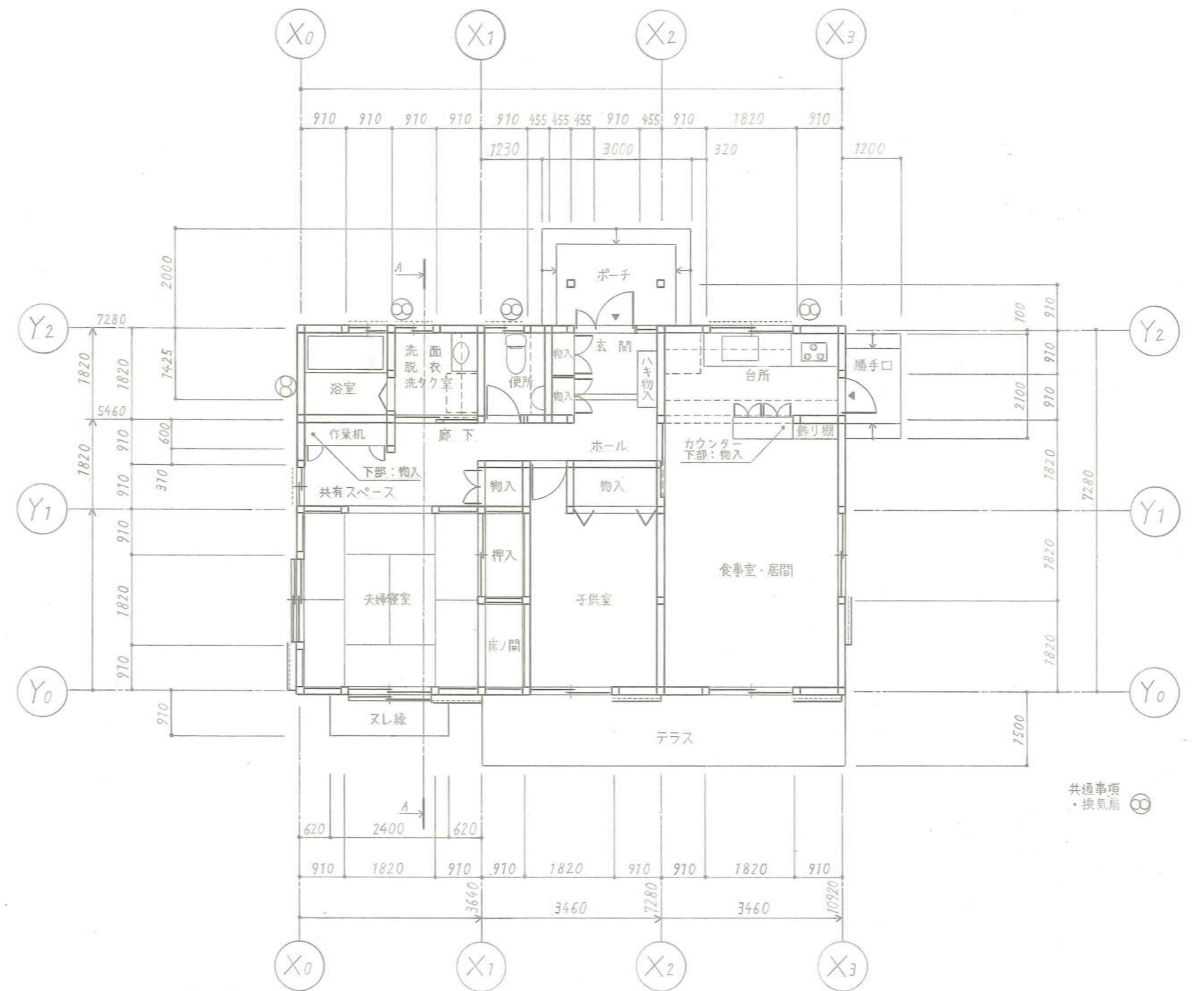

平面図 1:100

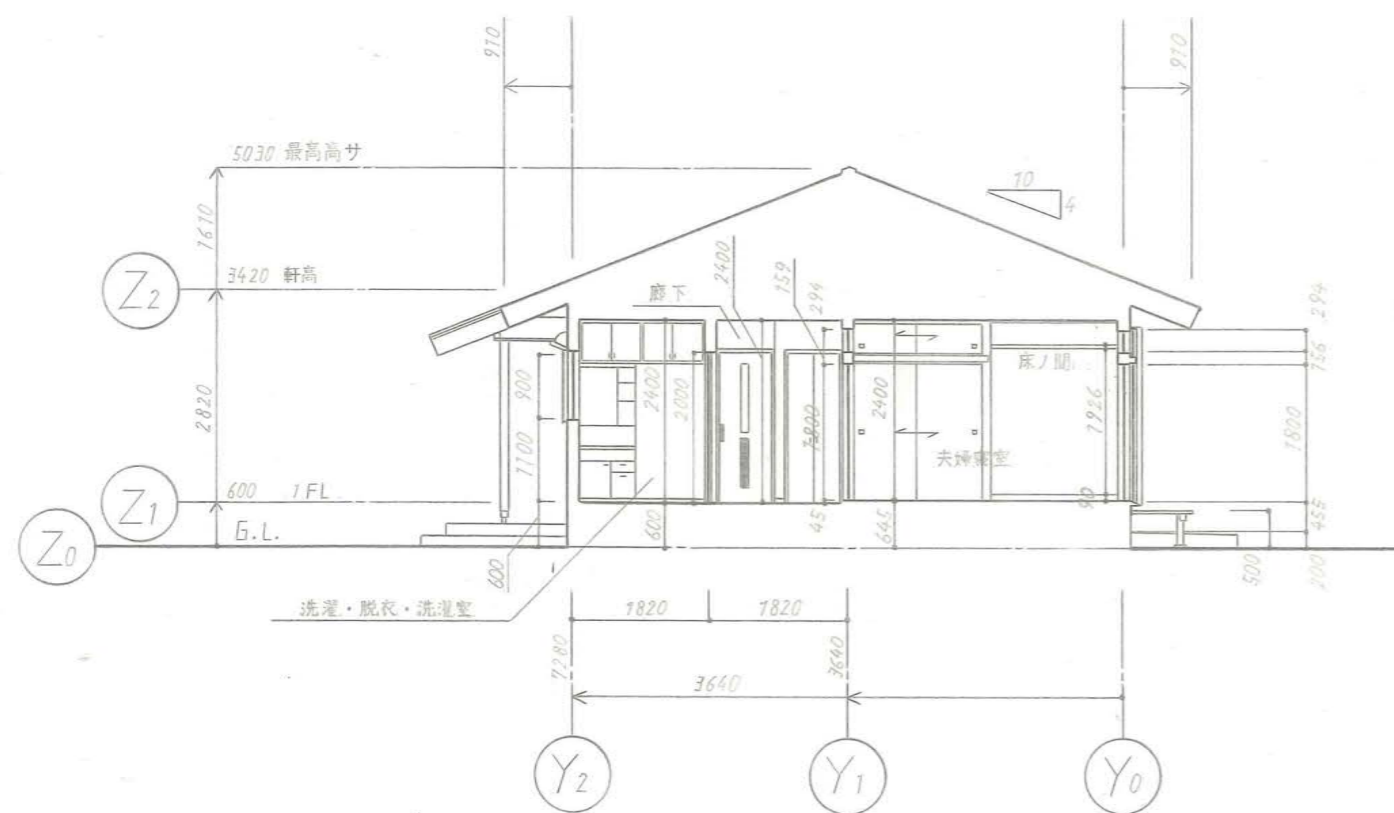

A-A断面図

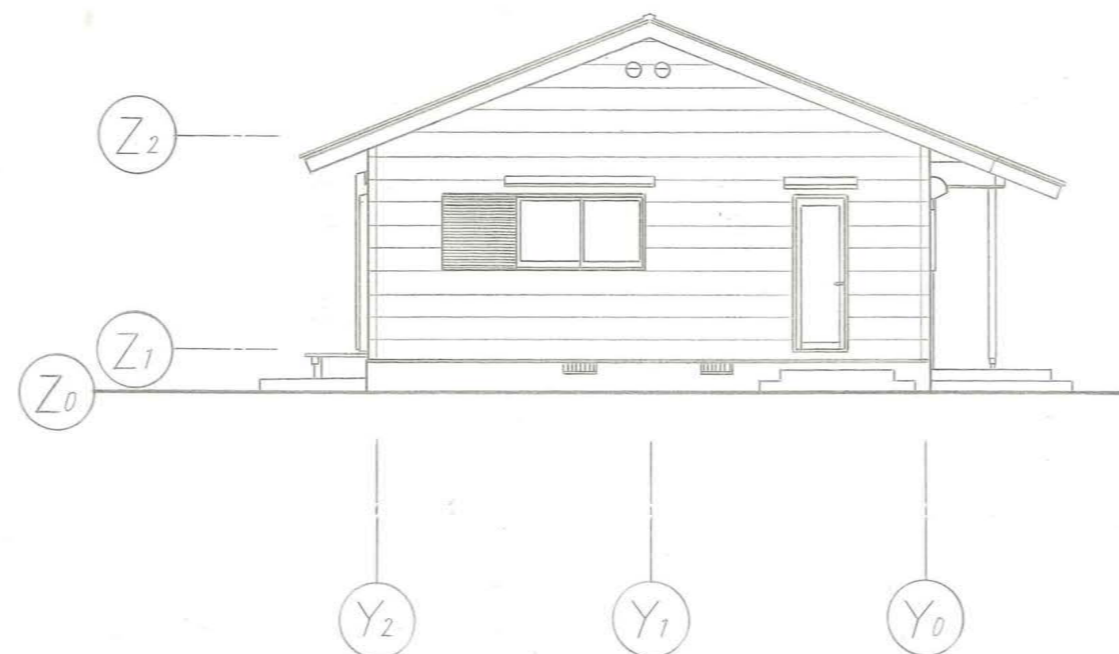

東立面図



北立面図

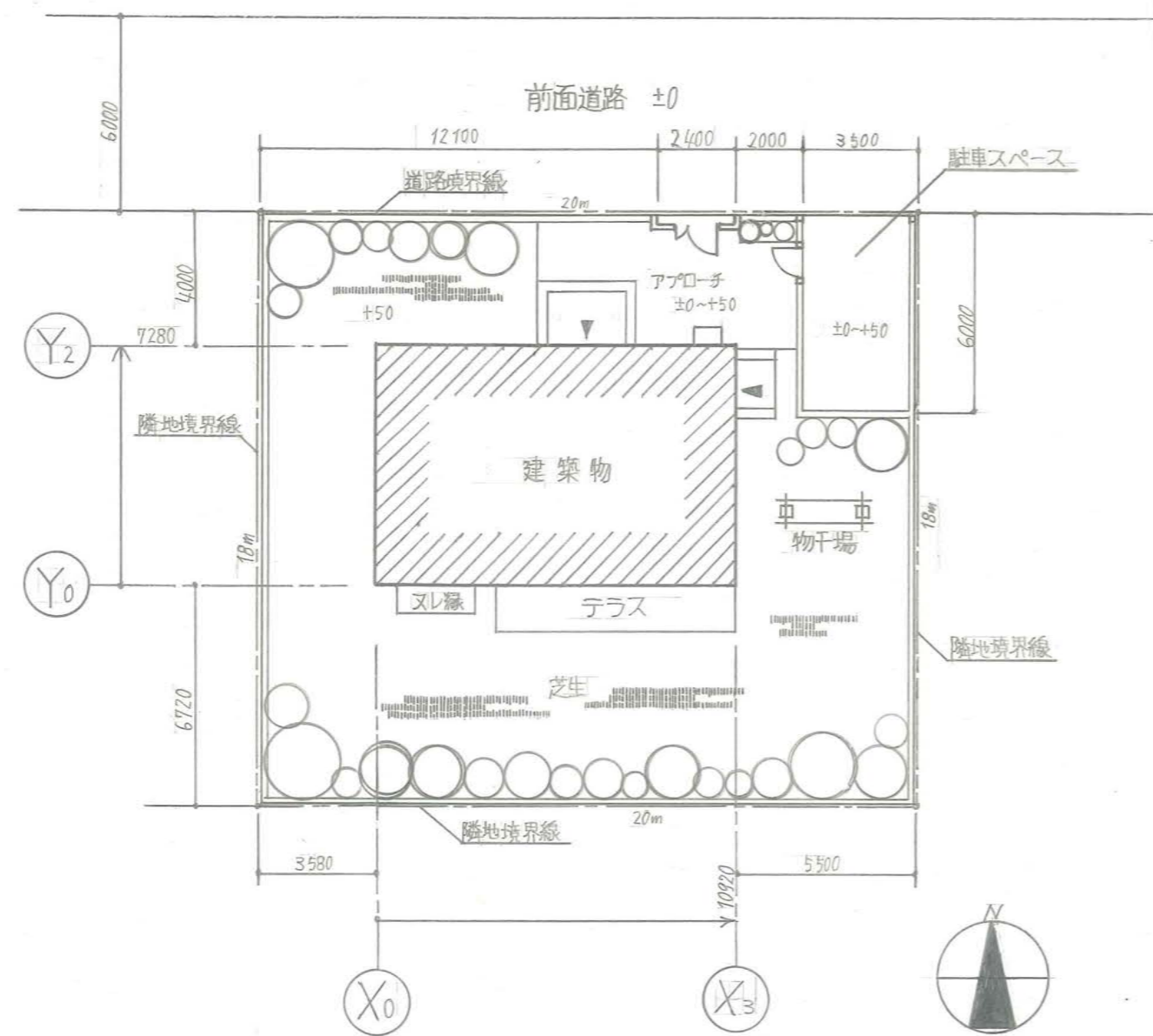

配置図 1:200

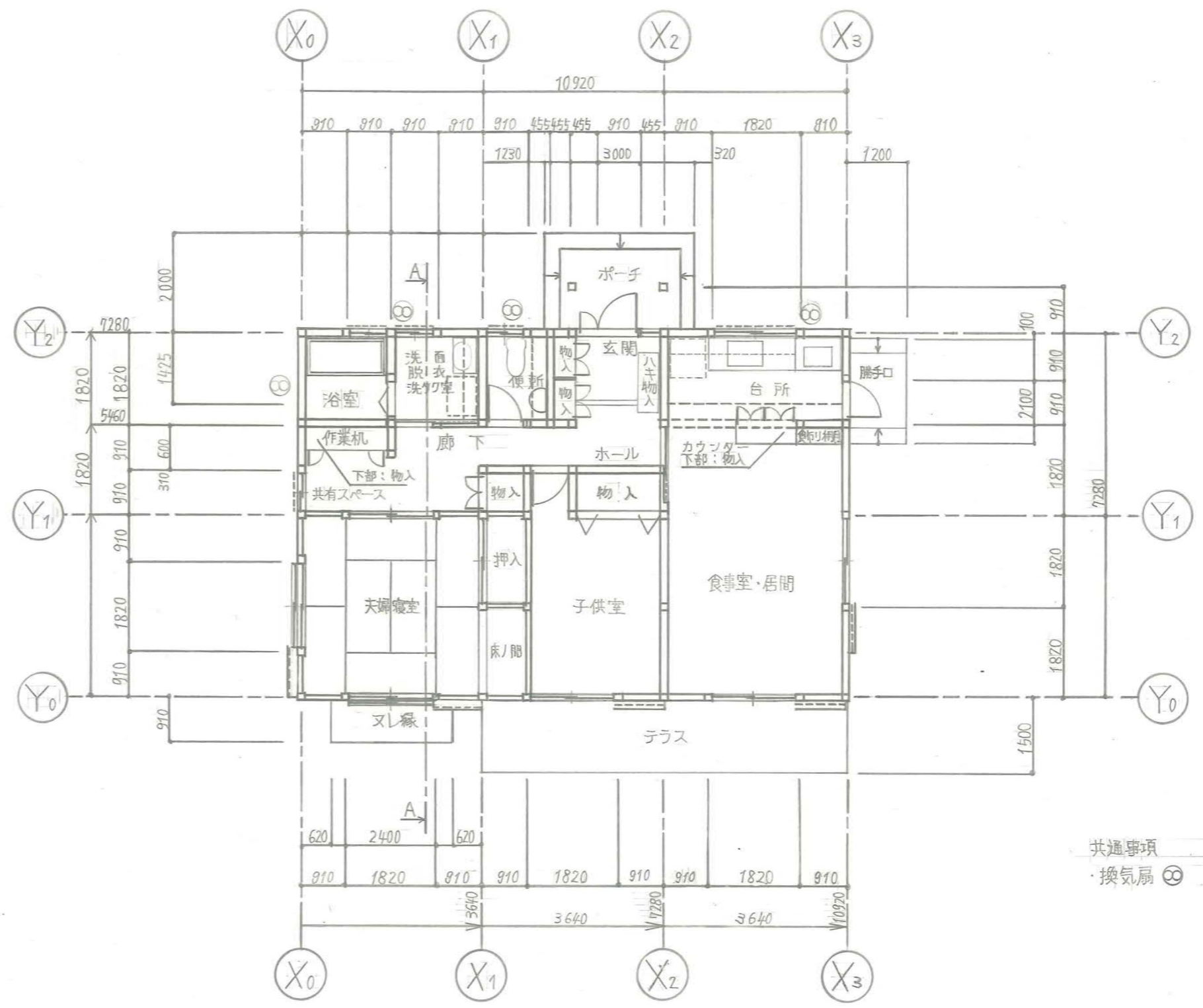

平面図 1:100

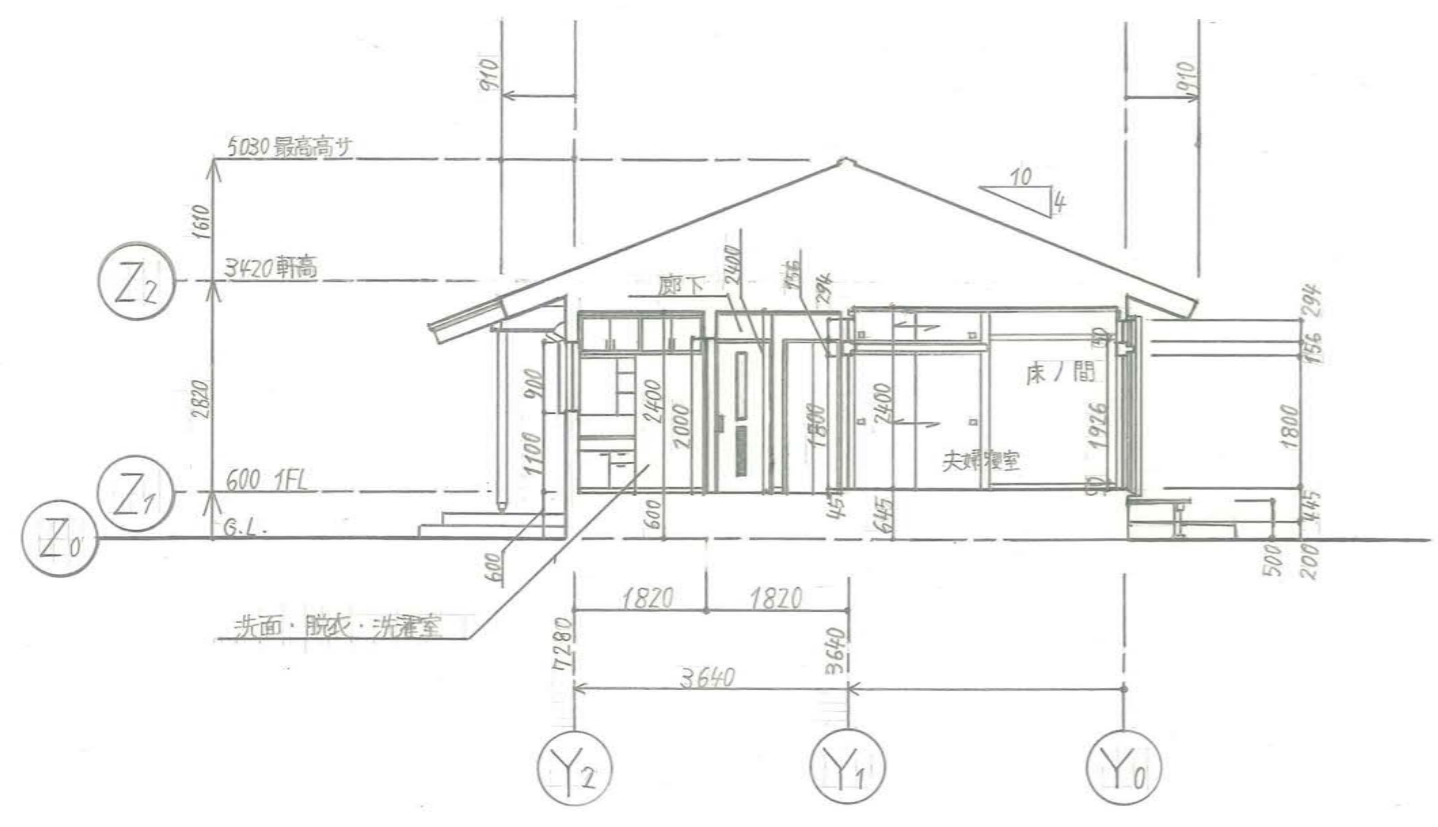

A-A断面図

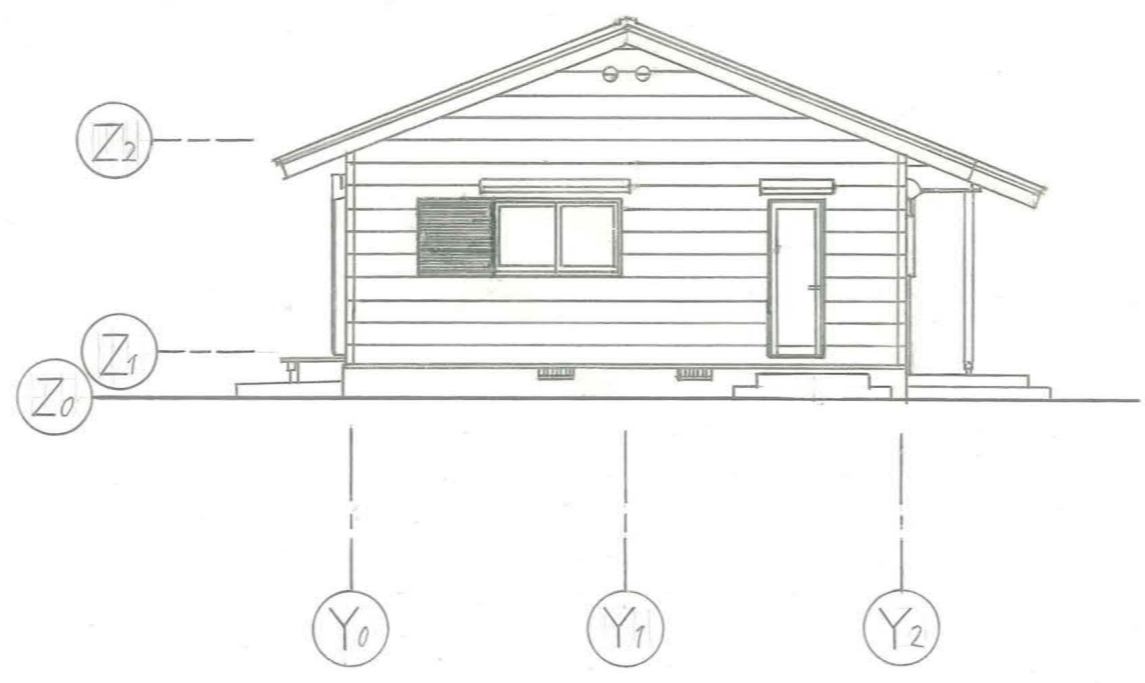

東立面図

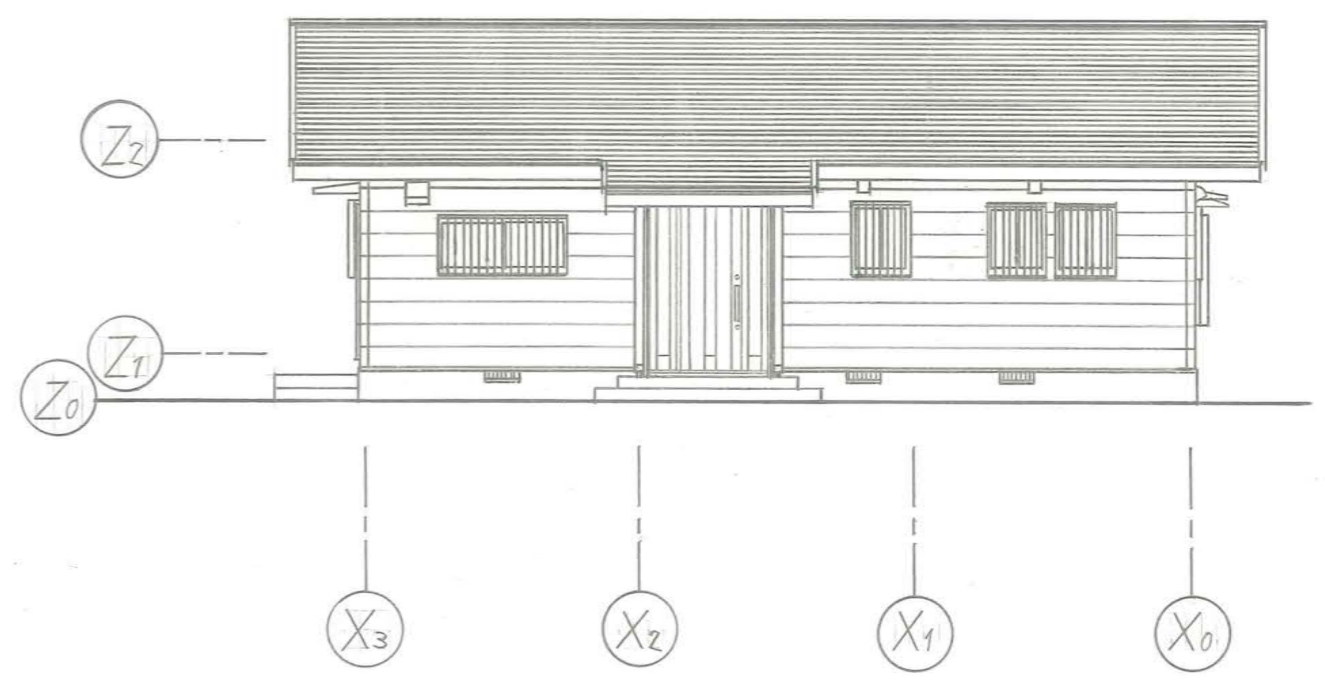

北立面図

共通事項
換気扇

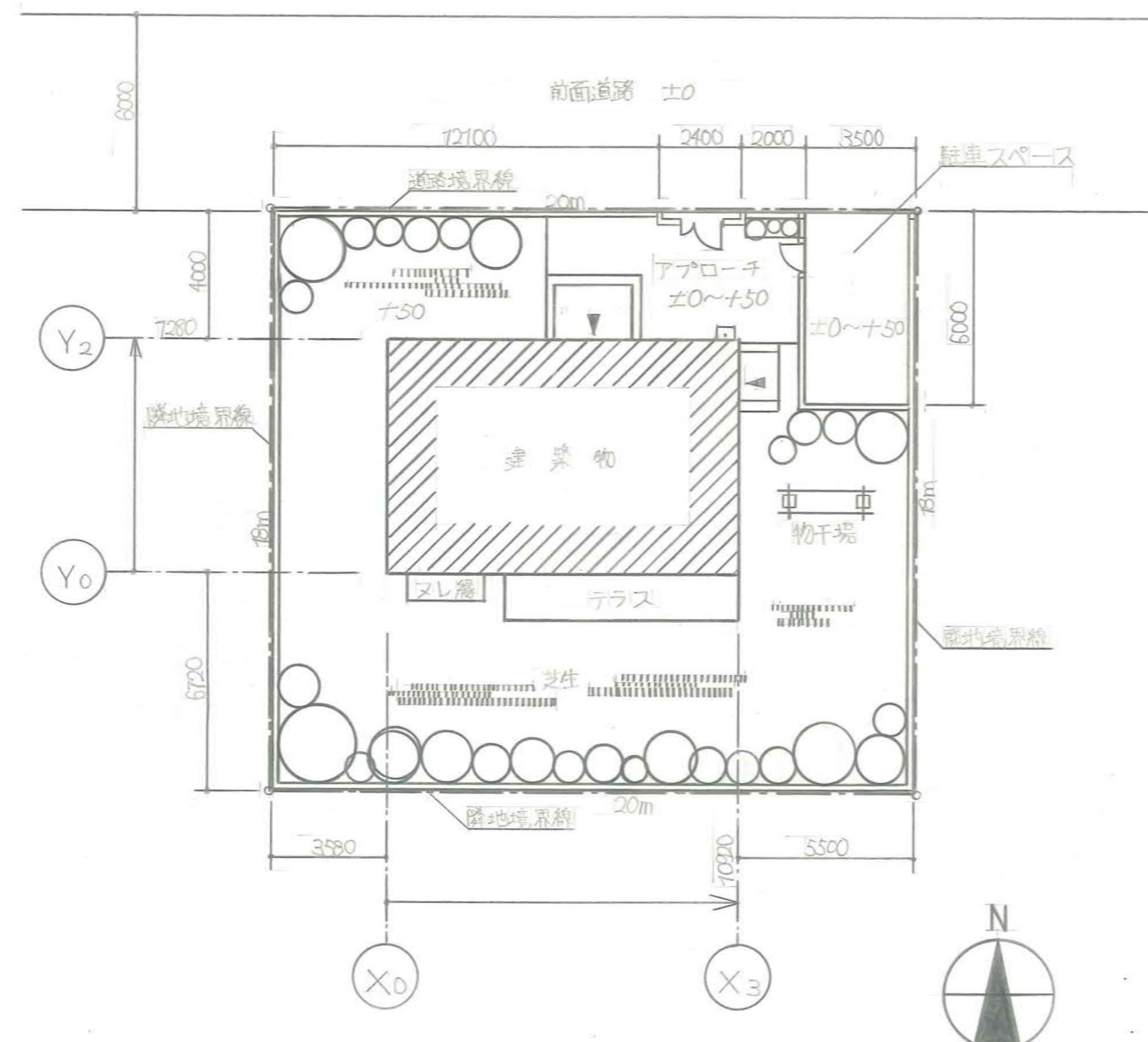

配置図 1:200

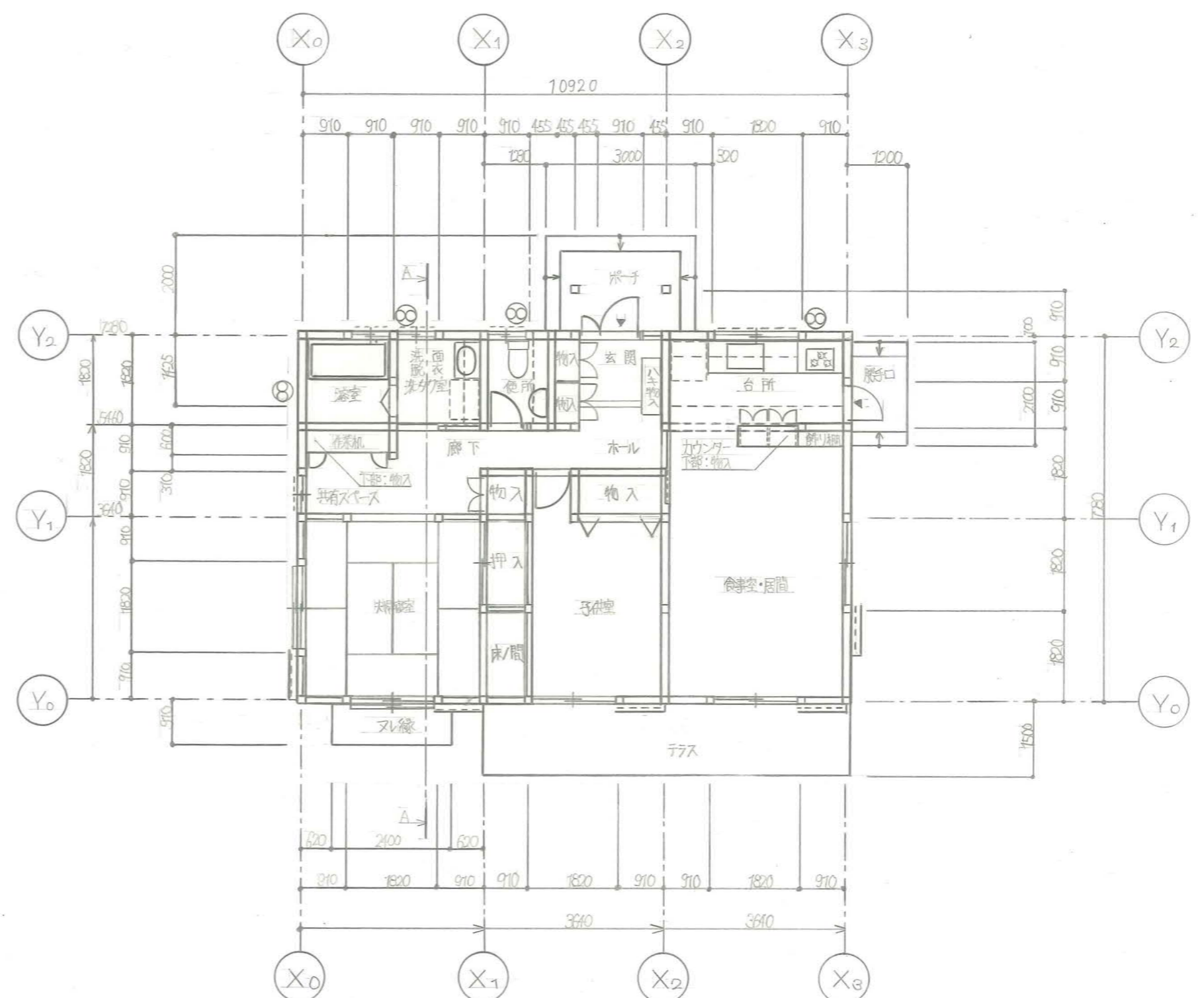

平面図 1:100

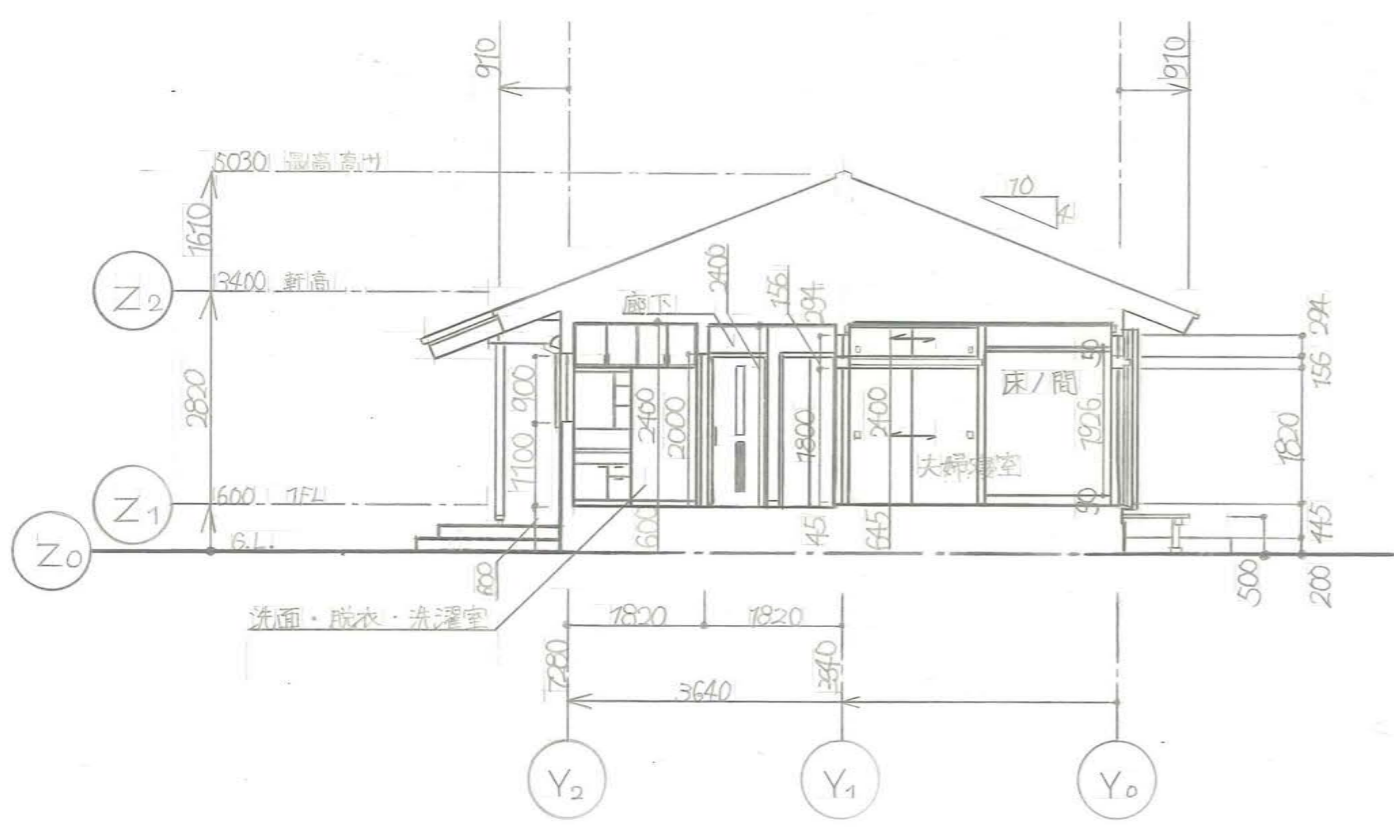

A-A断面図

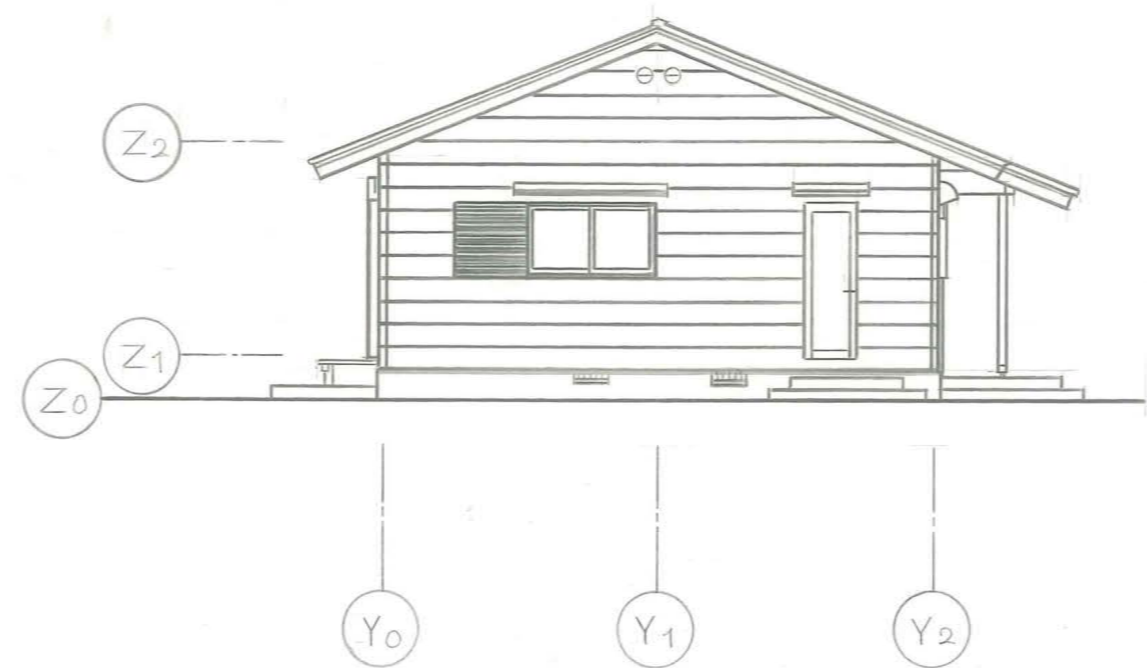

東立面図



北立面図

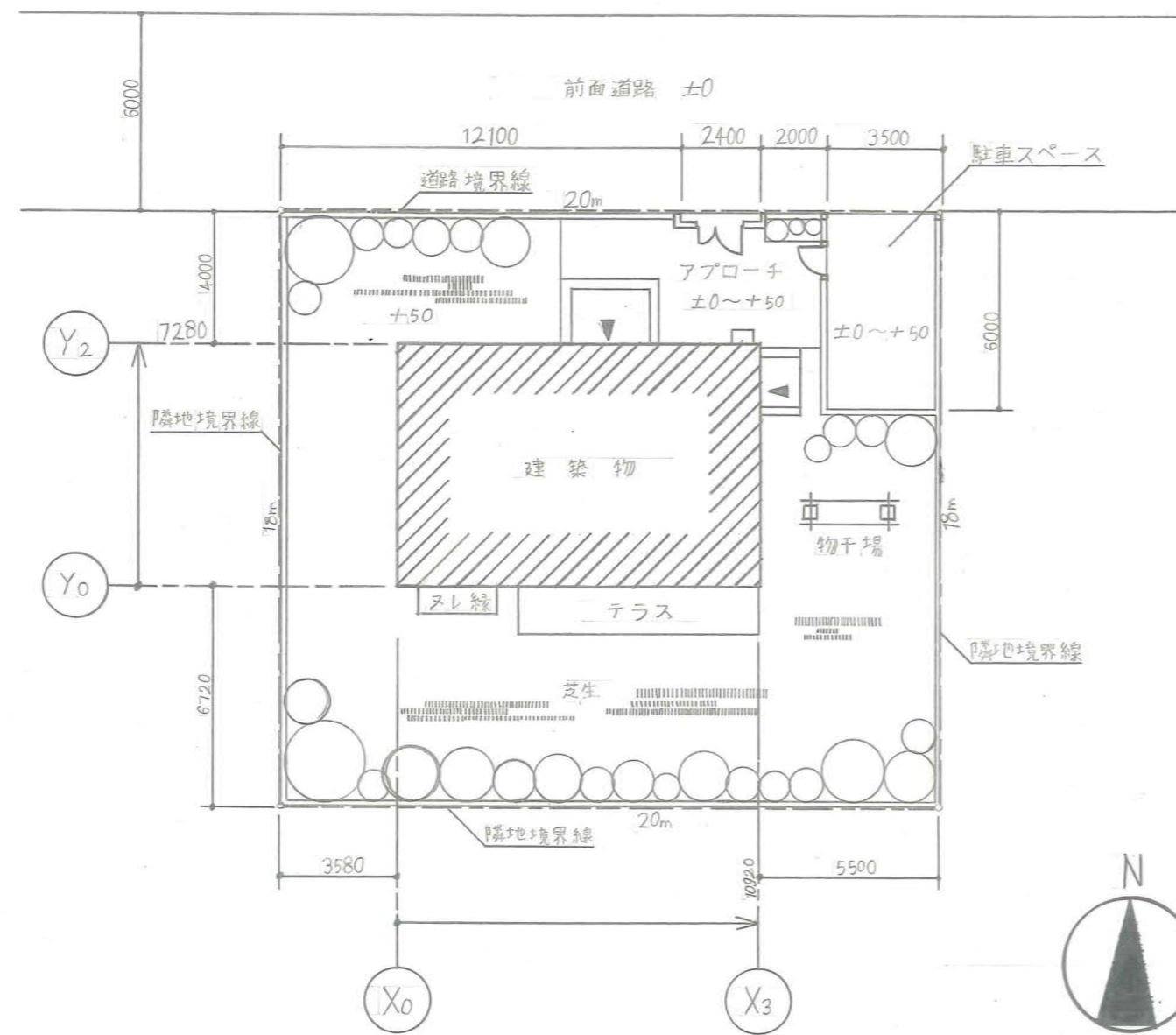

配置図 1:200

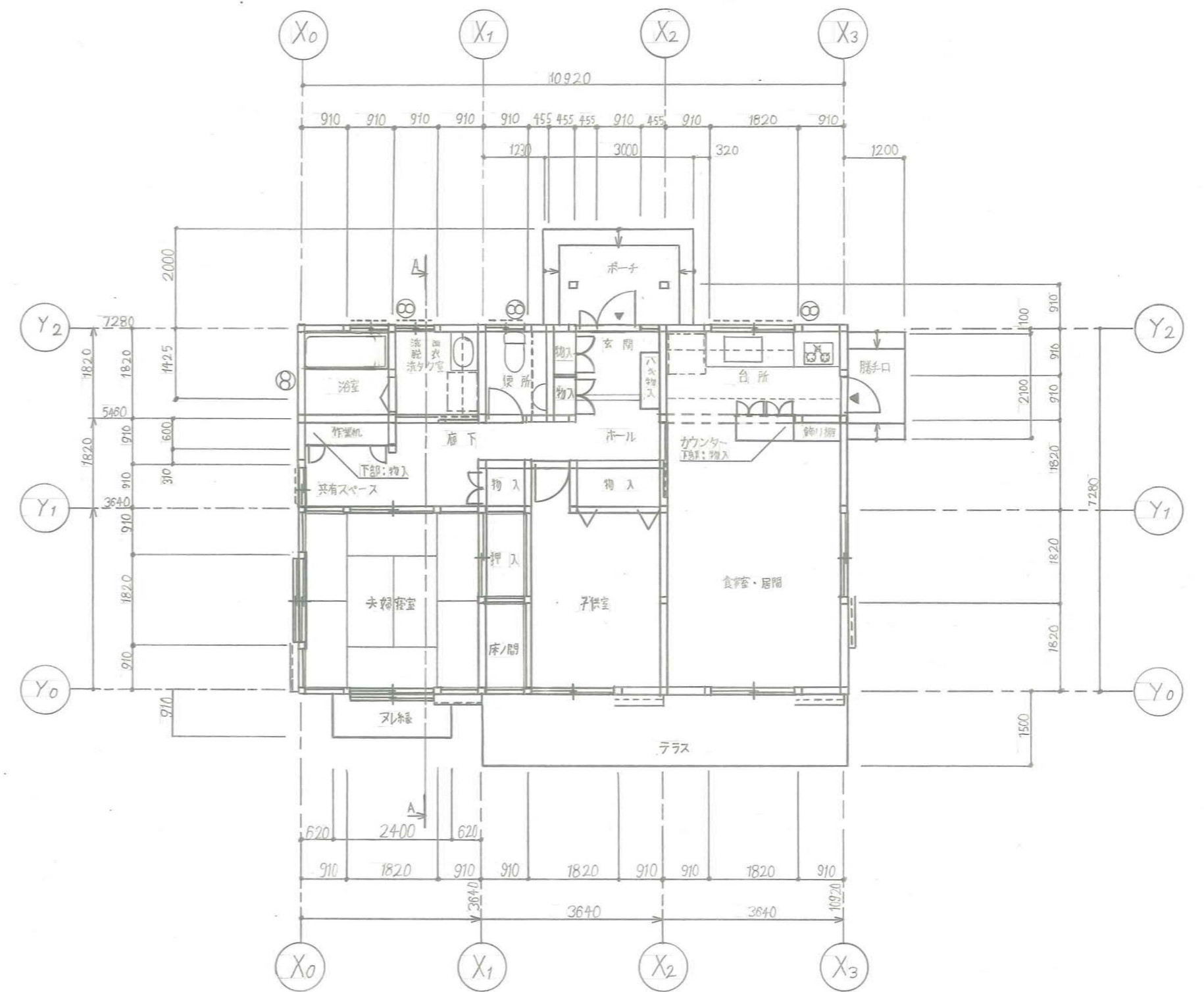

平面図 1:100

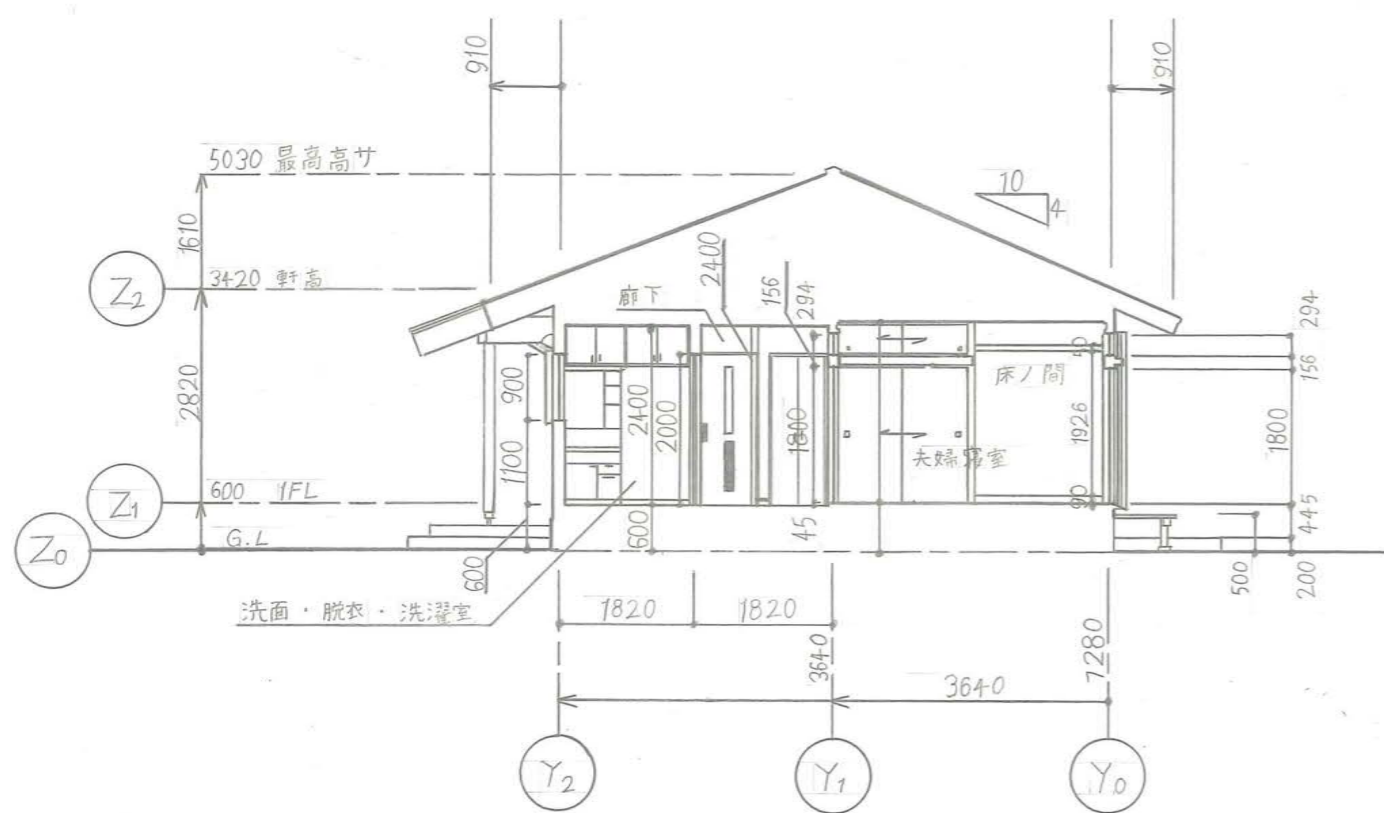

A-A断面図

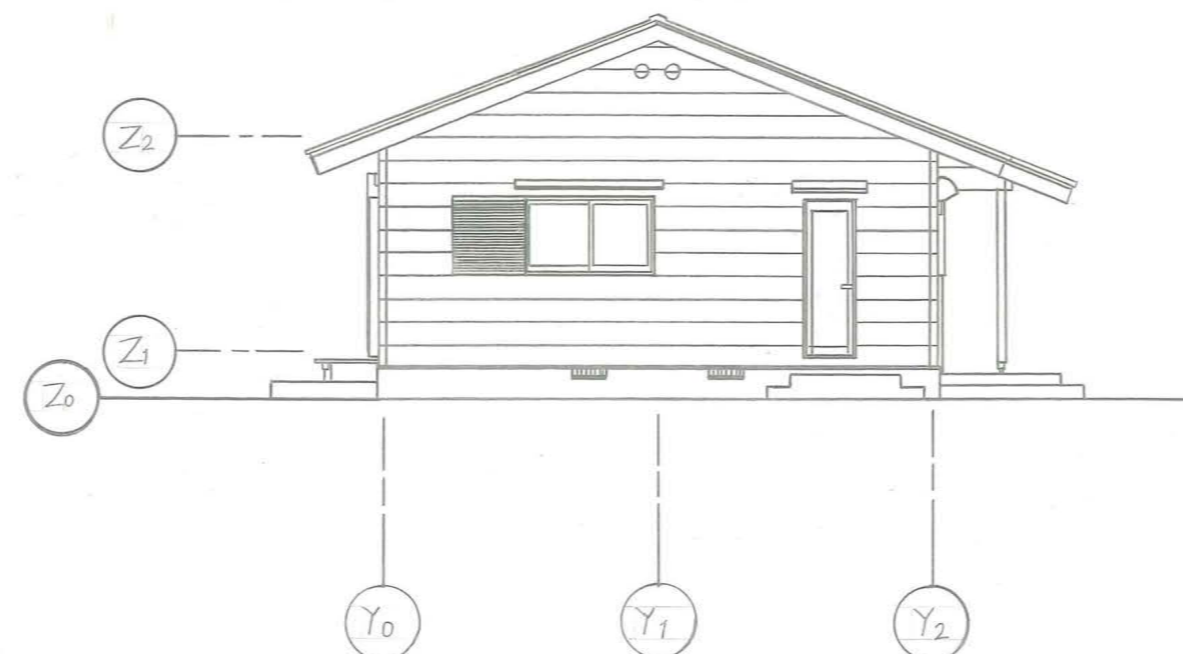

東立面図



北立面図

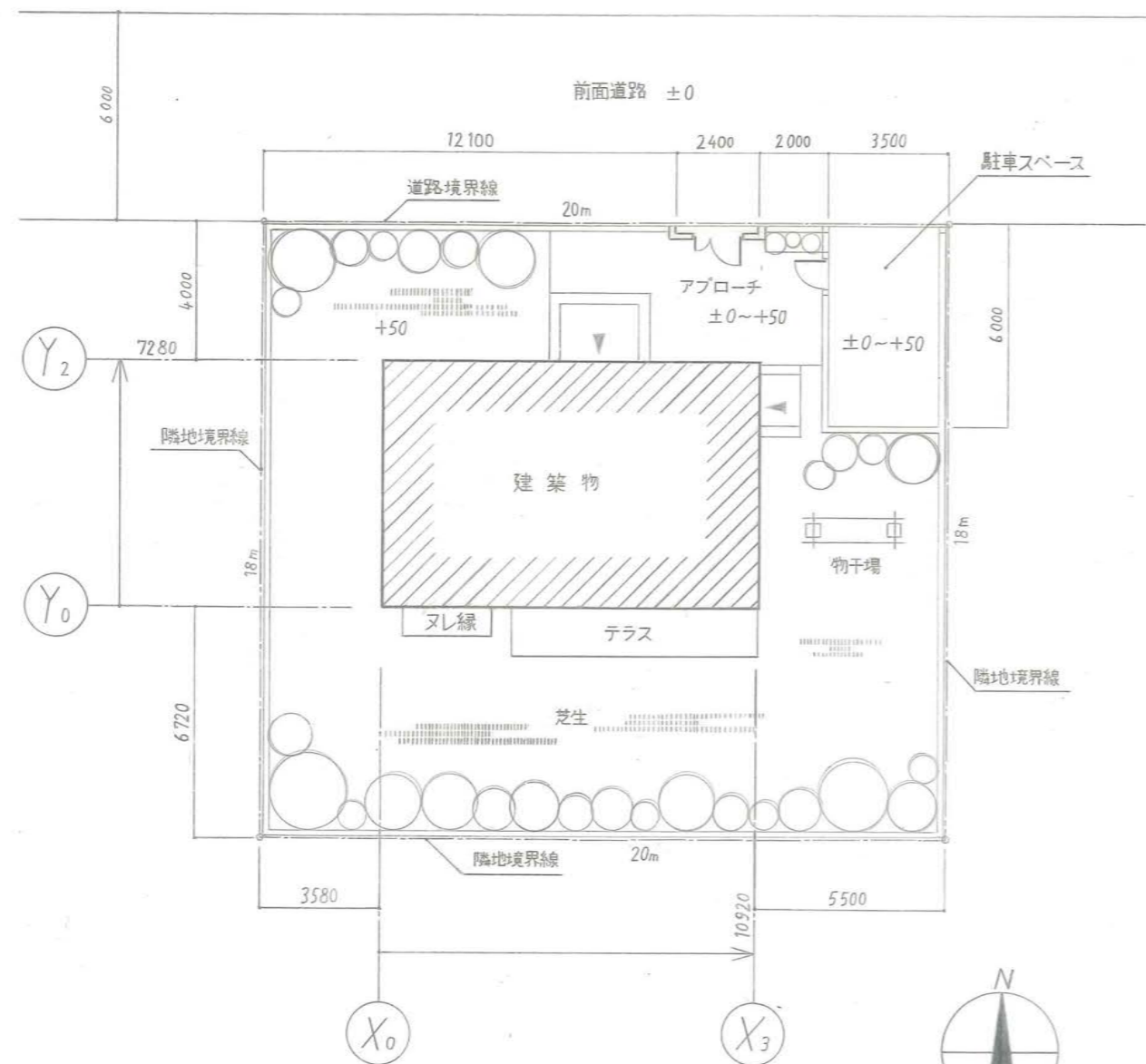

配置図 1:200

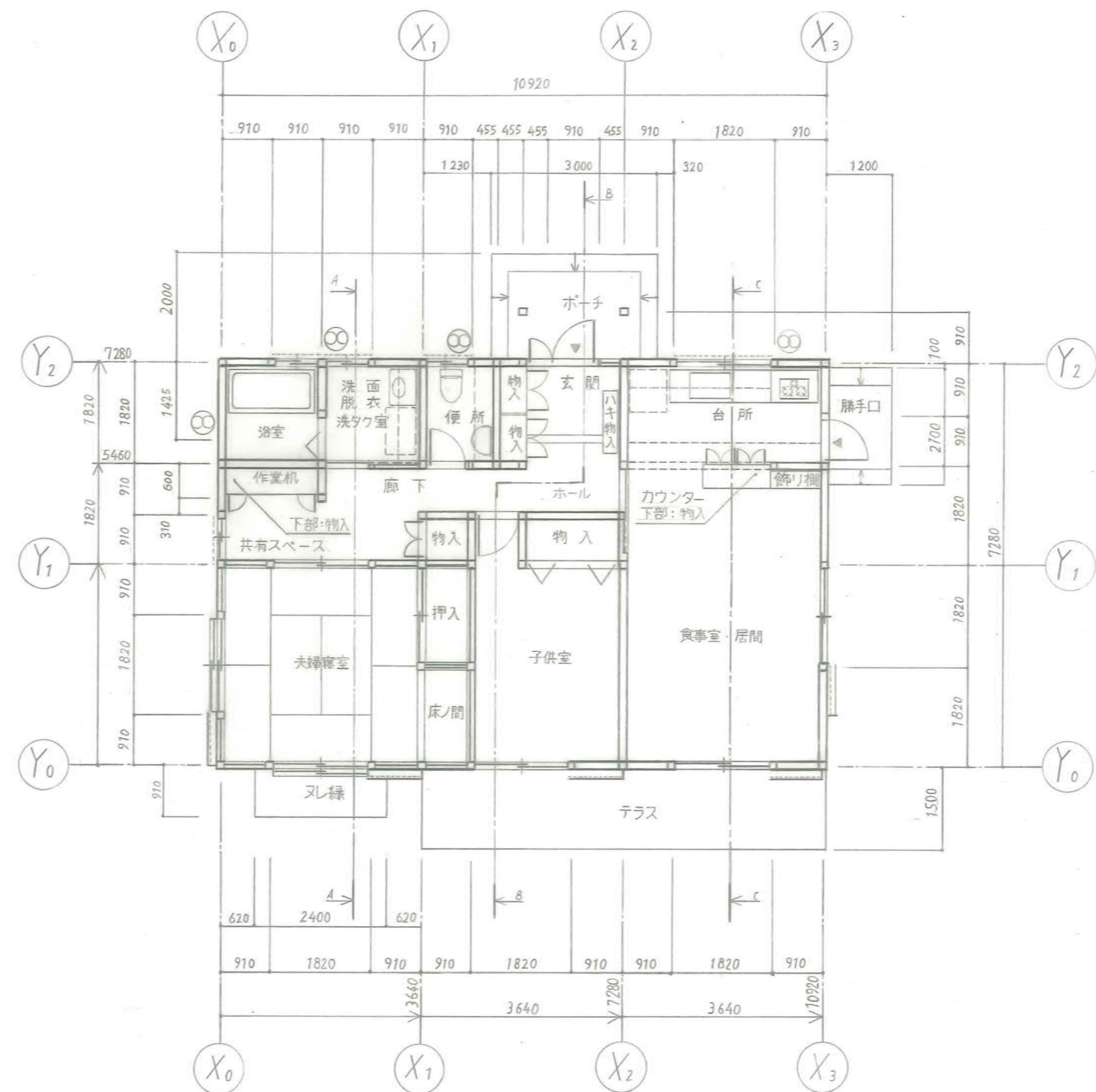

平面図 1:100

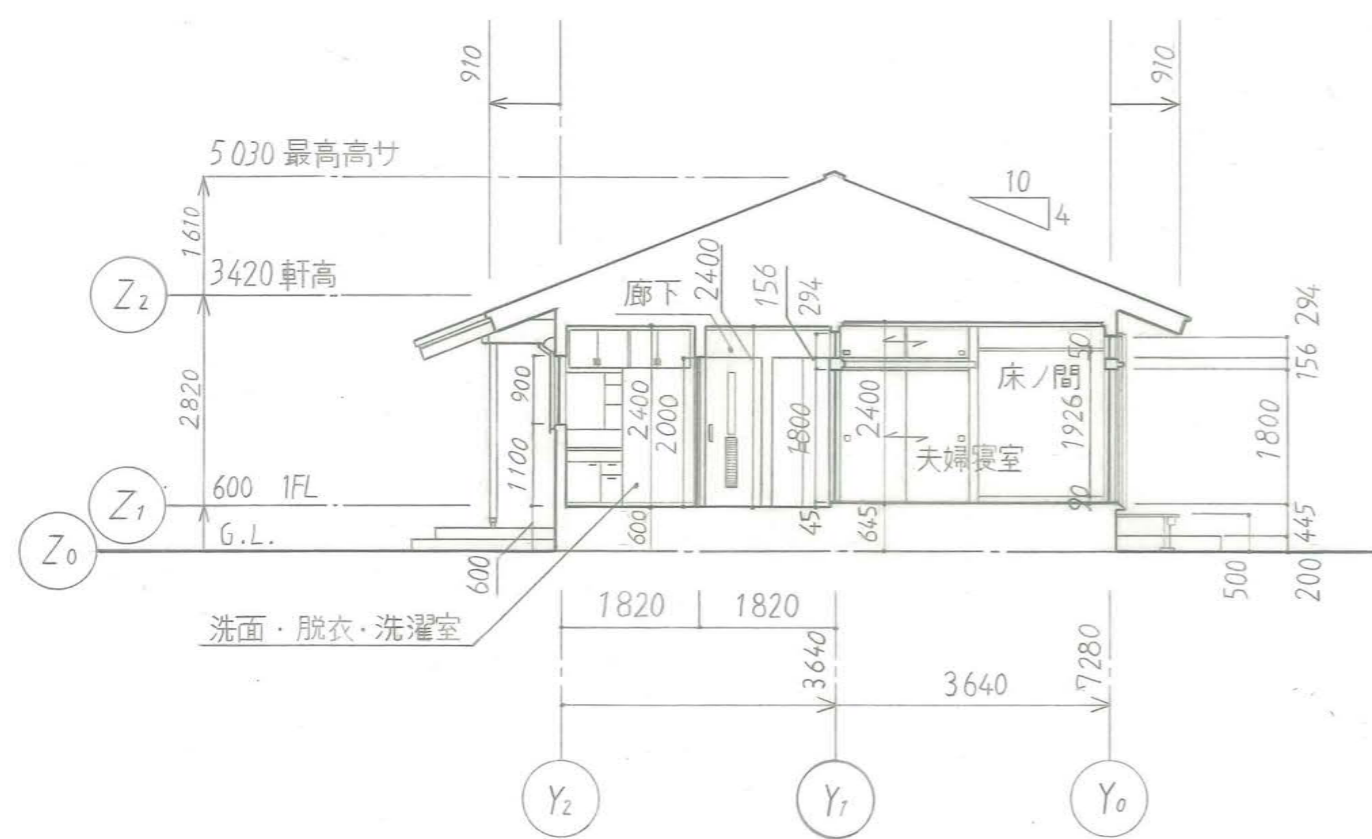

A-A断面図

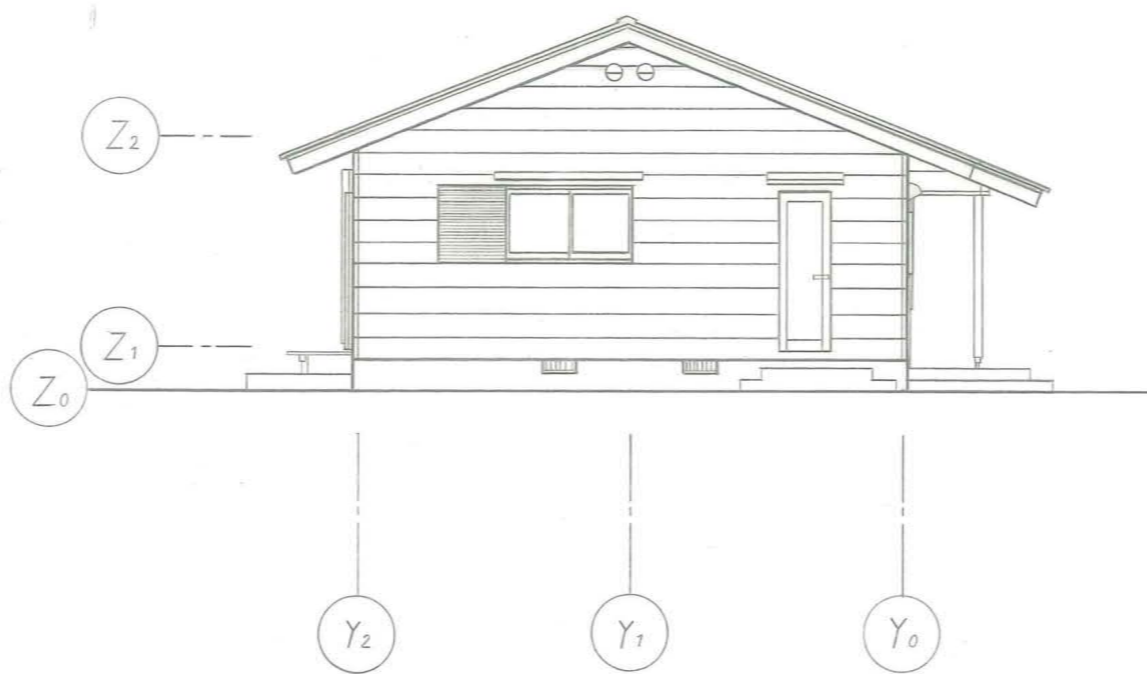

東立面図

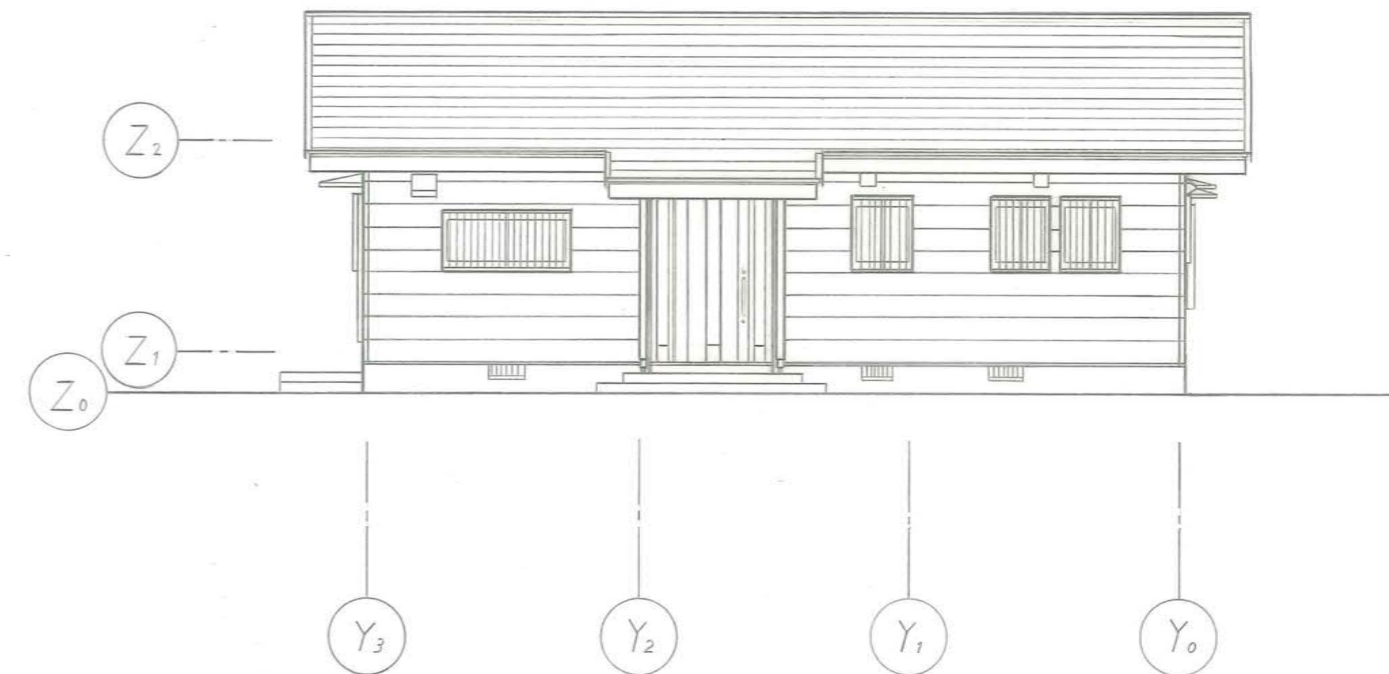

北立面図

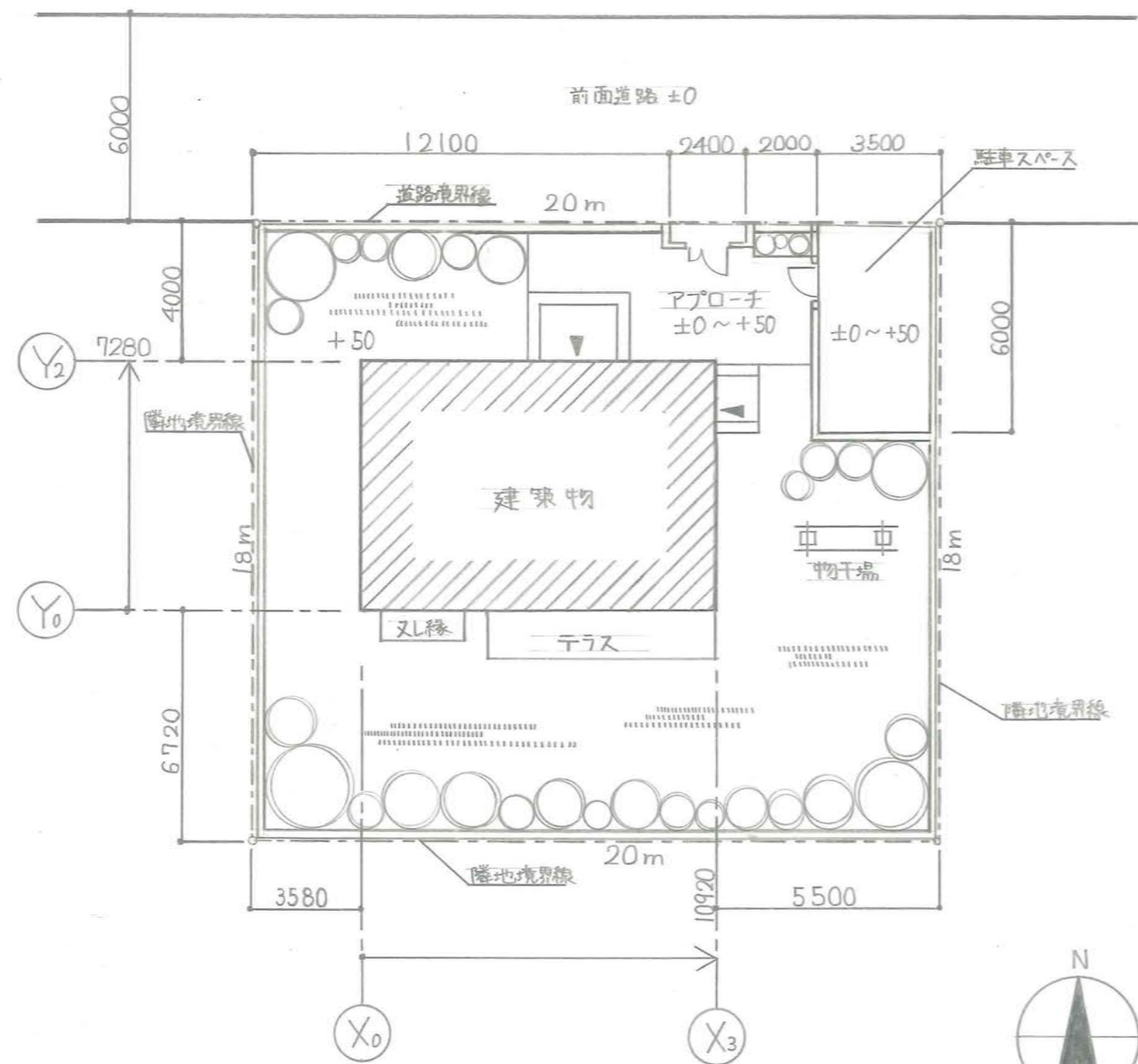

配置図 1:200

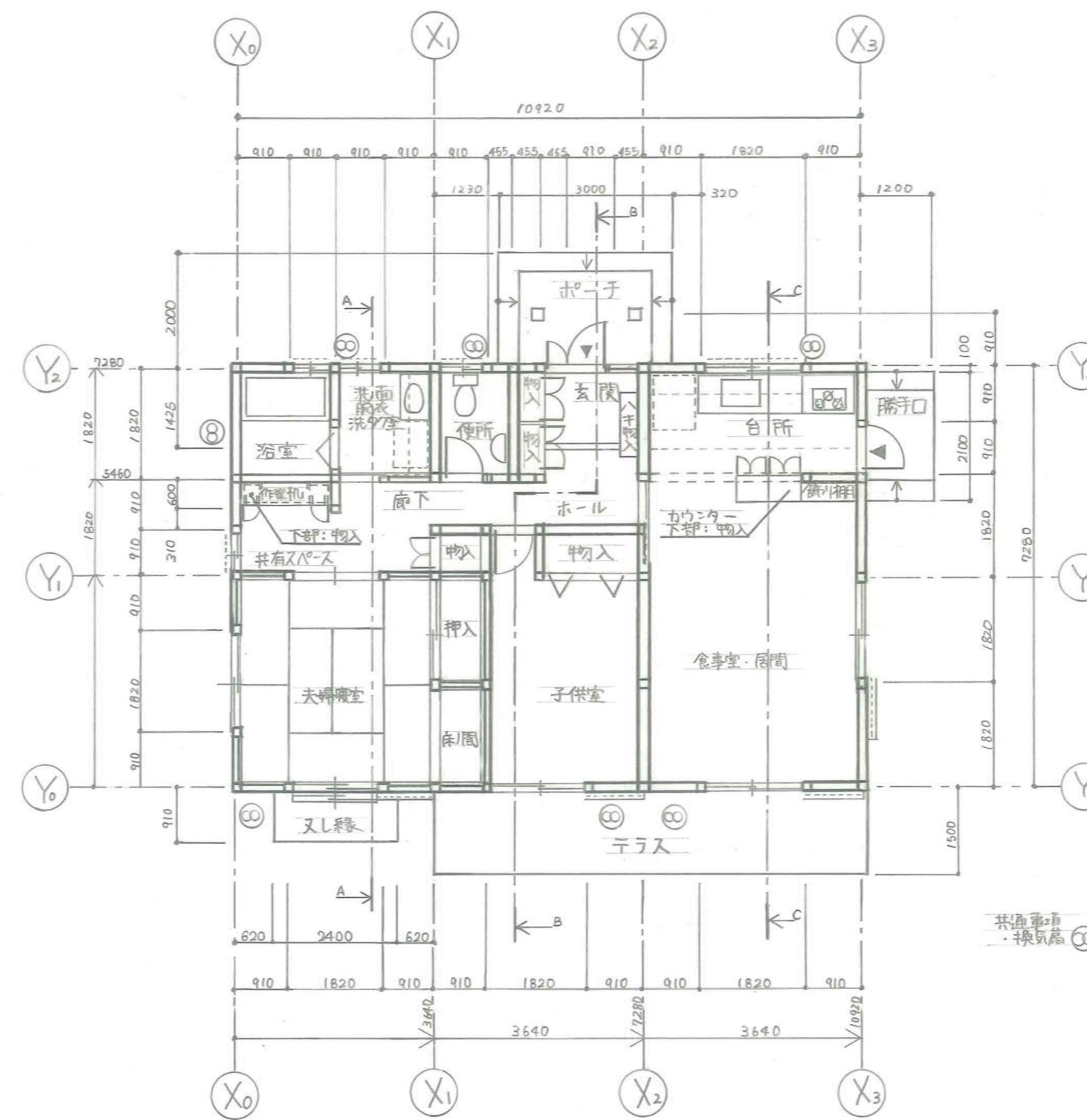

平面図 1:100

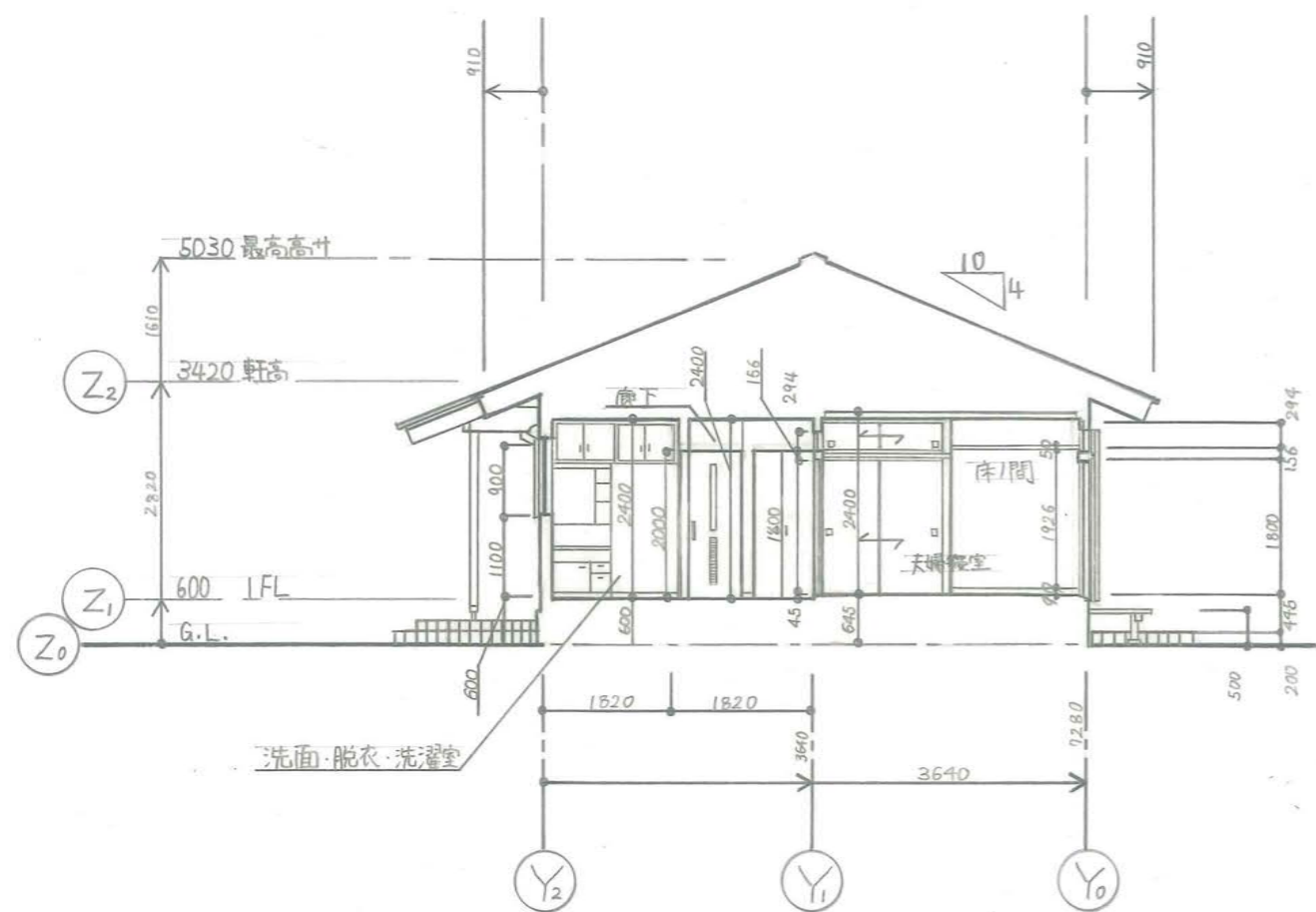

A-A断面図 1:100

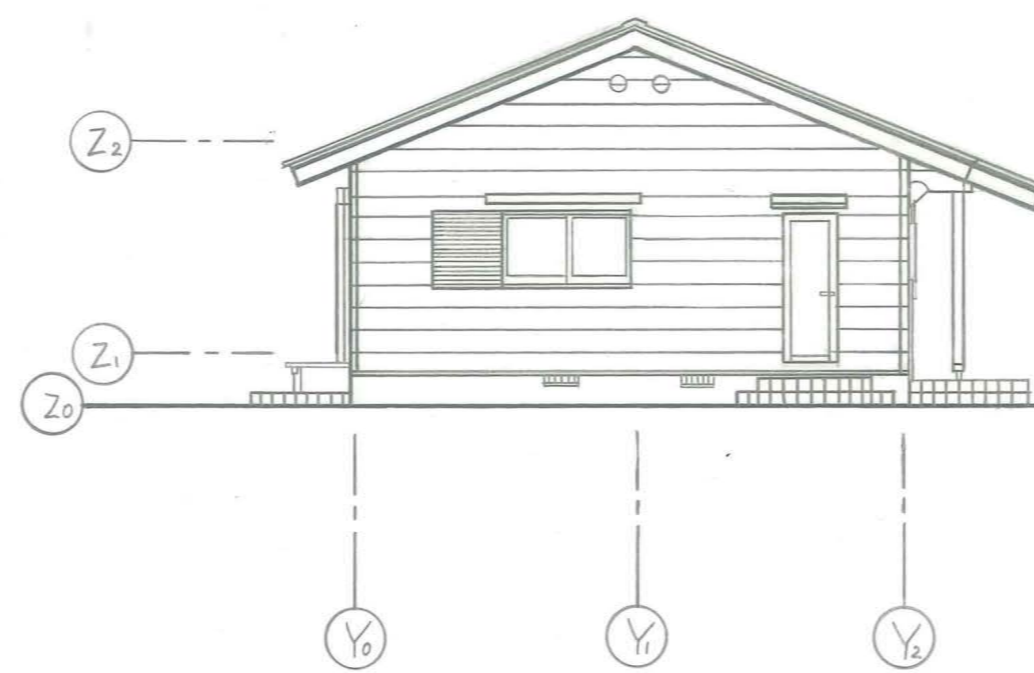

東立面図 1:100

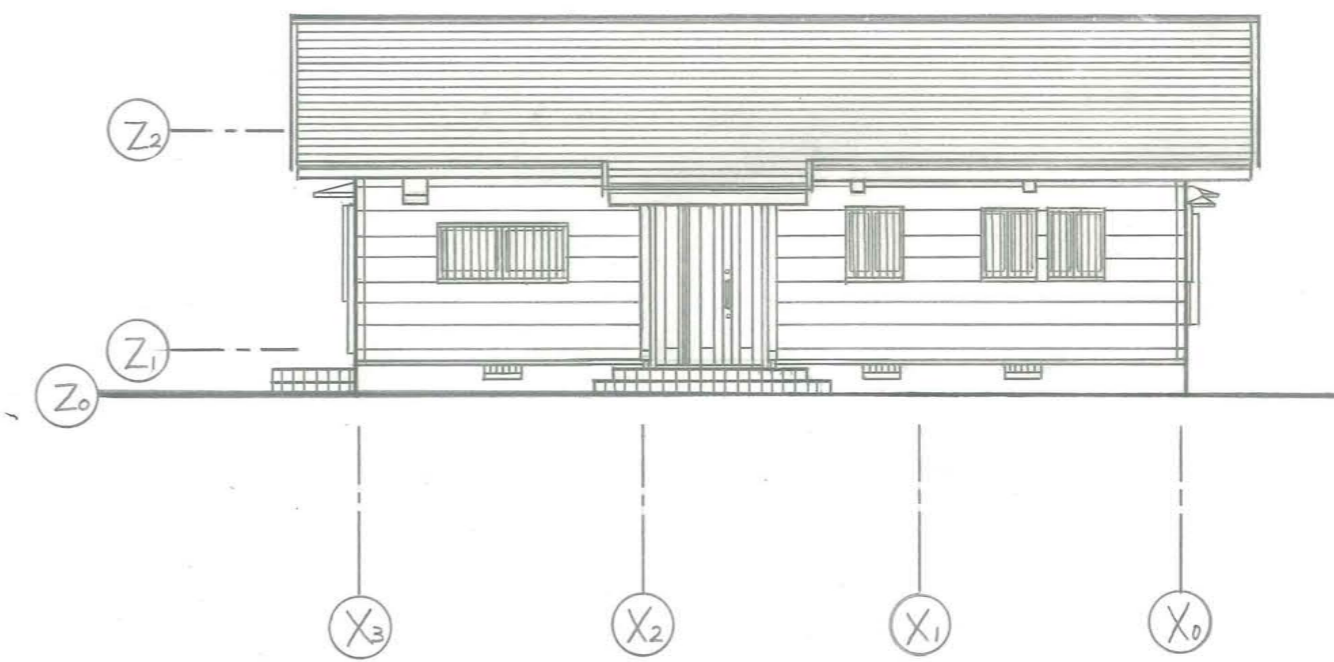

北立面図 1:100

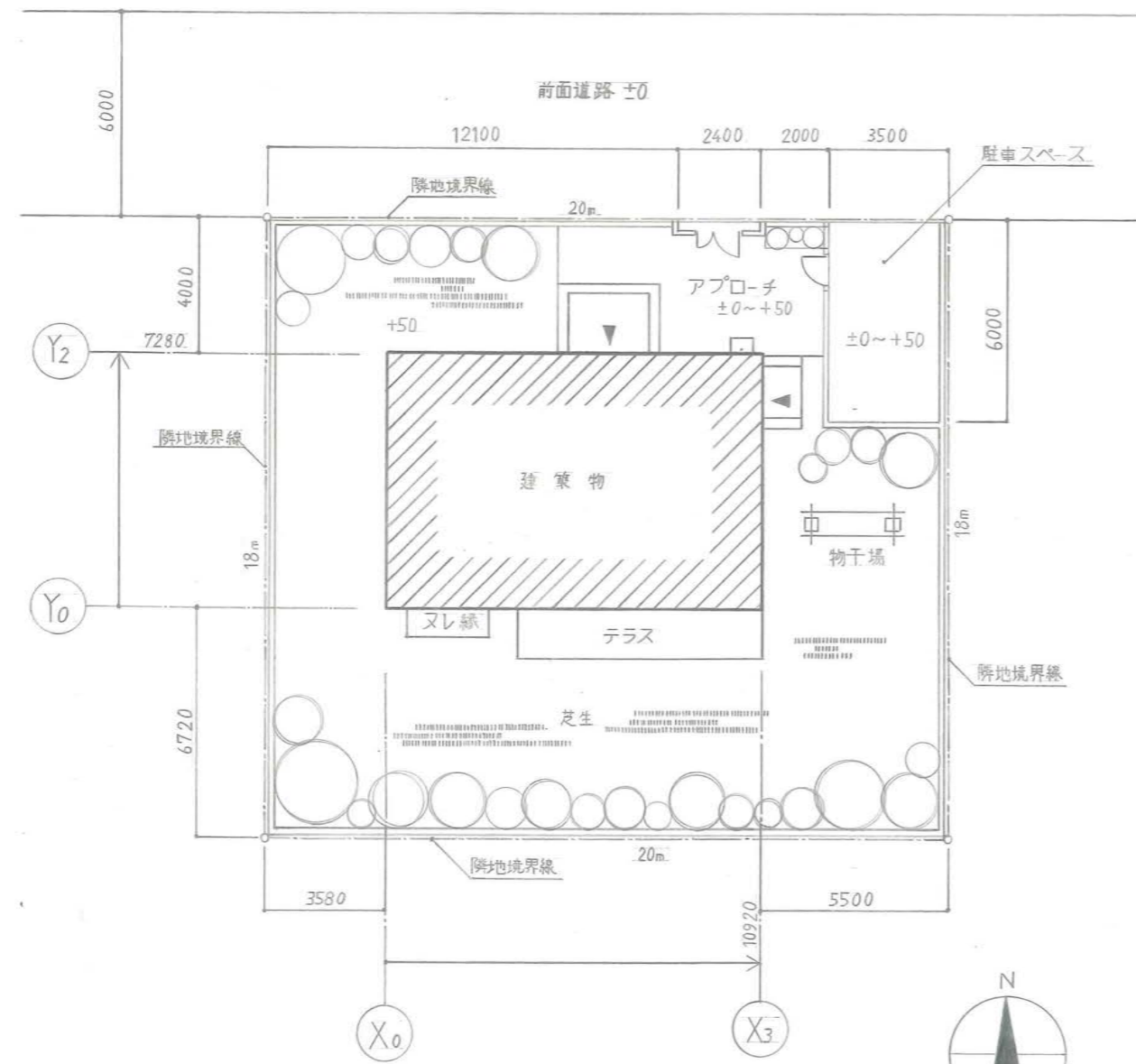

配置図 1:200

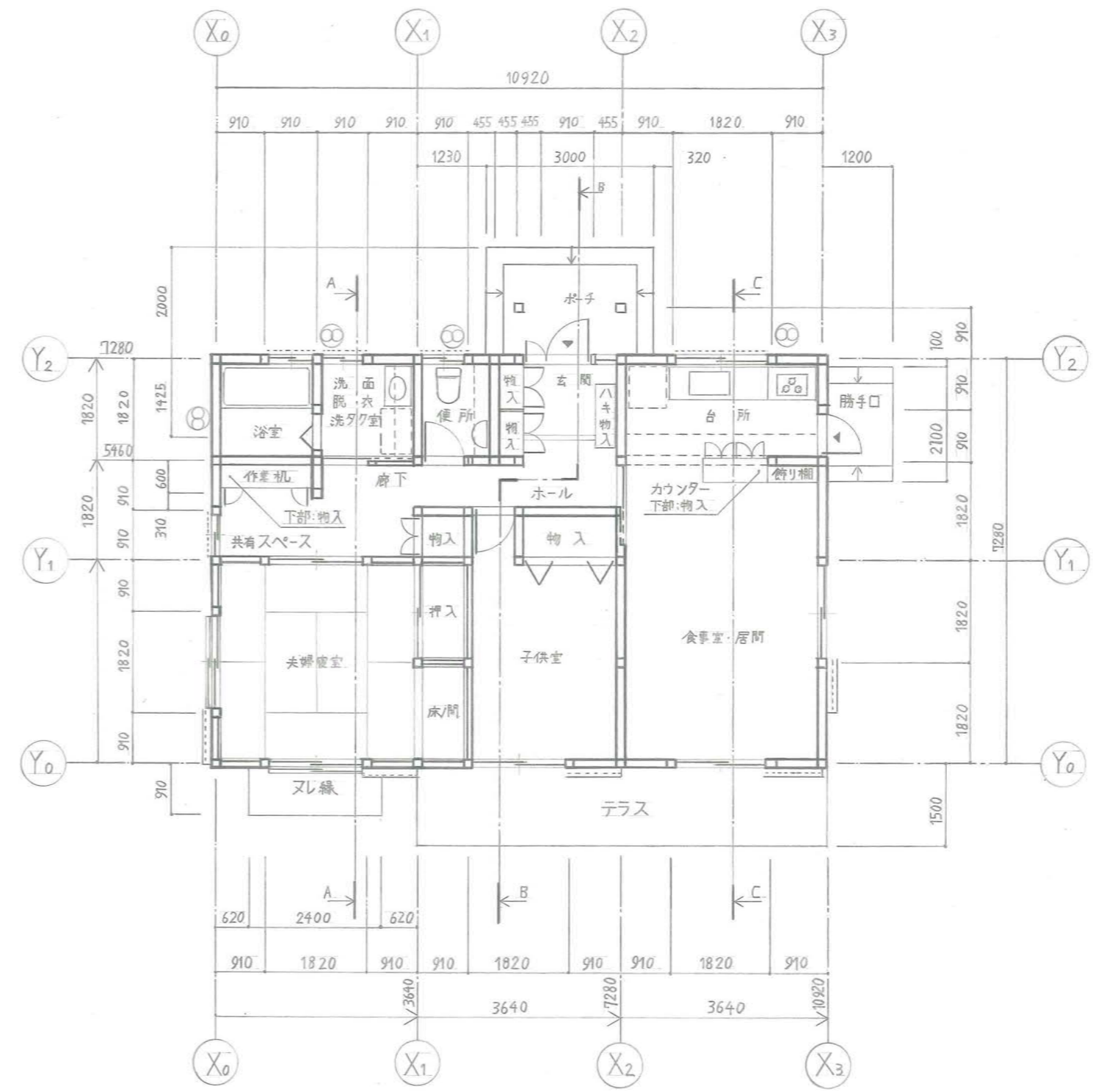

平面図 1:100

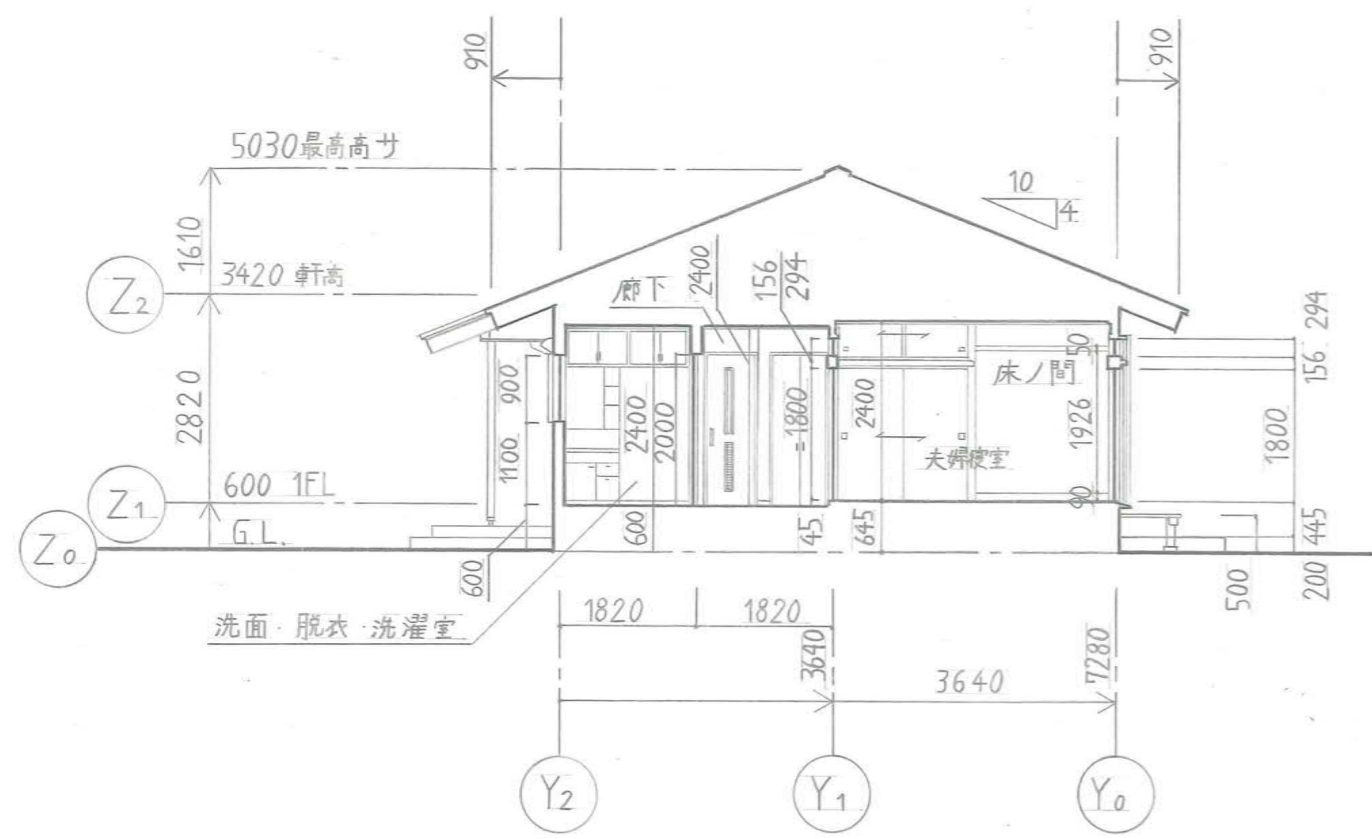

A-A断面図

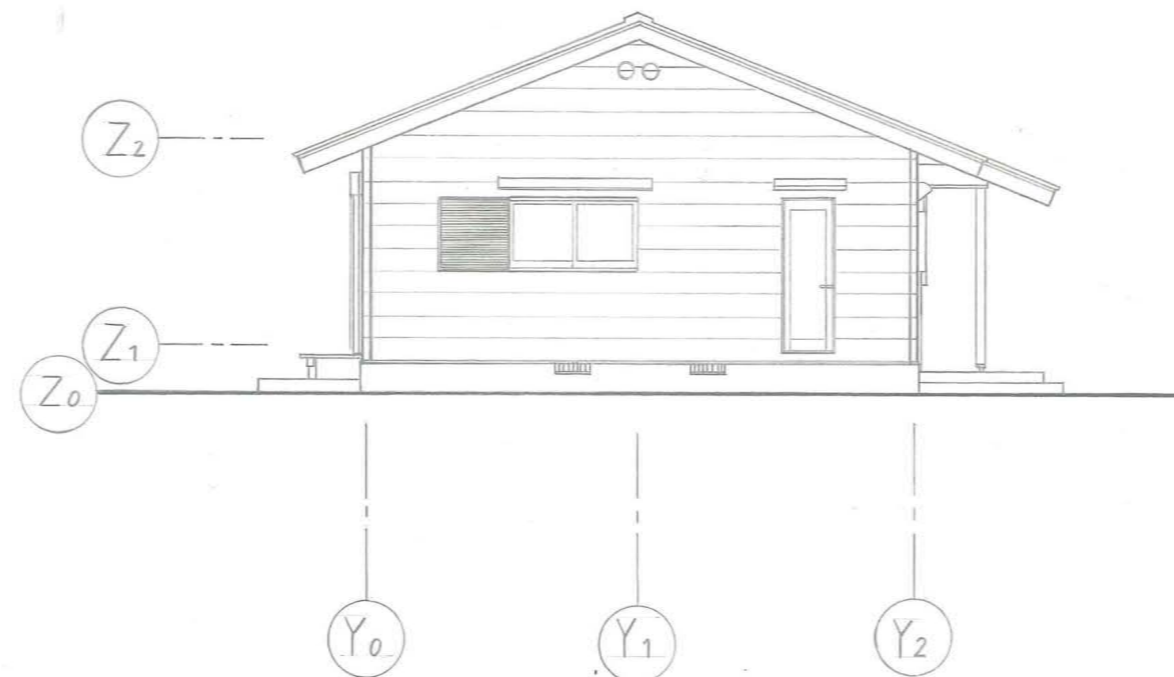

東立面図



北立面図

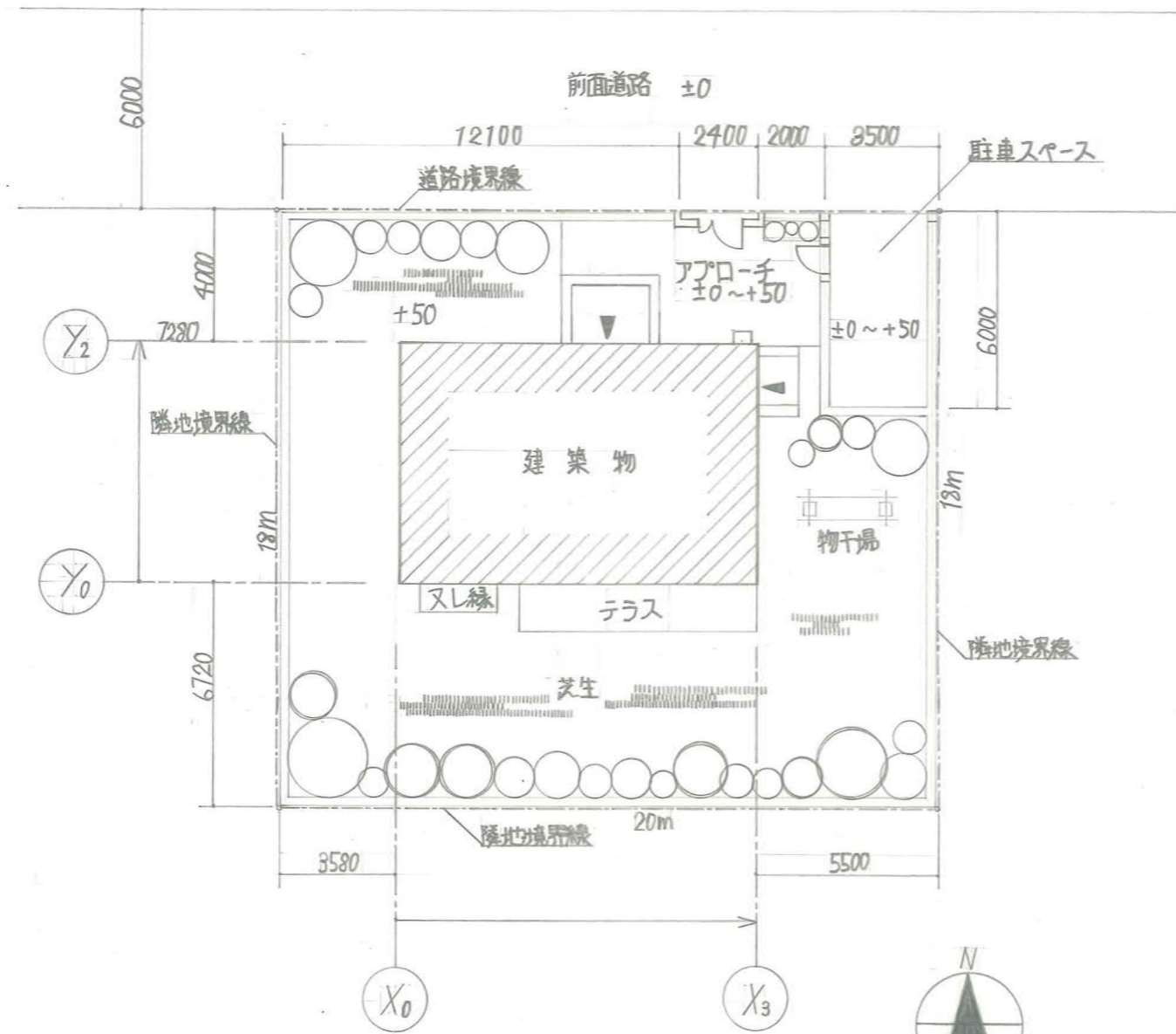

配置図 1:200

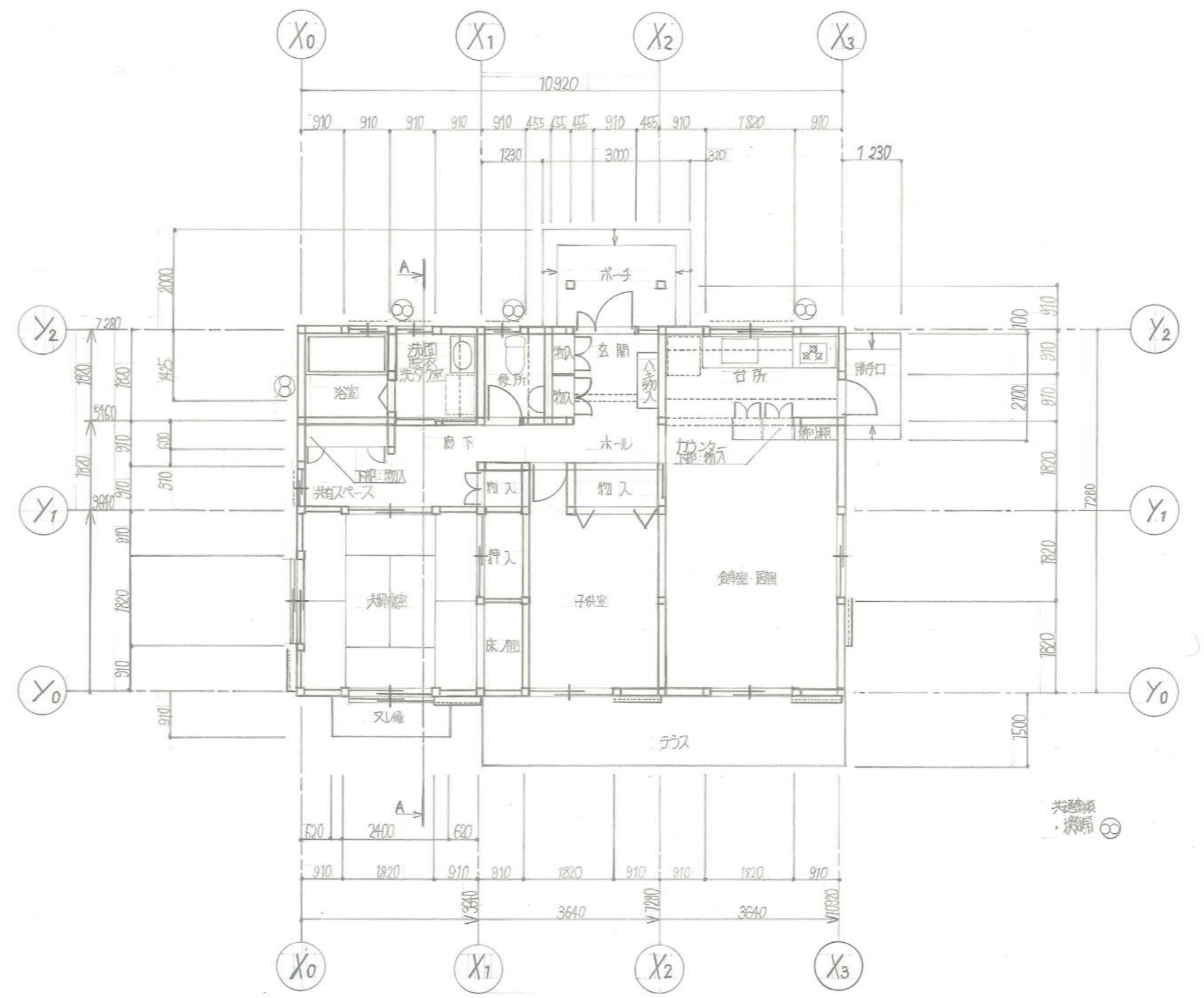

平面図 1:100

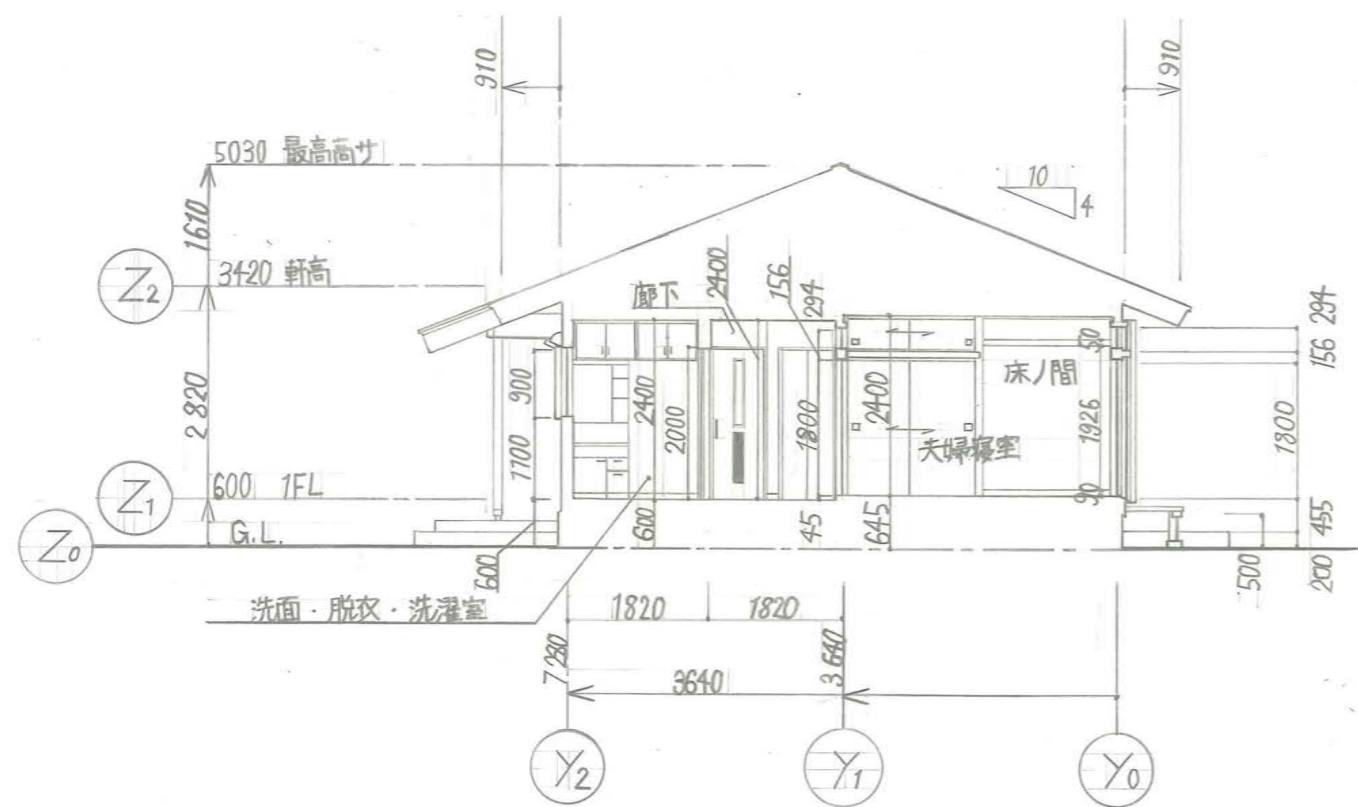

A-A断面図

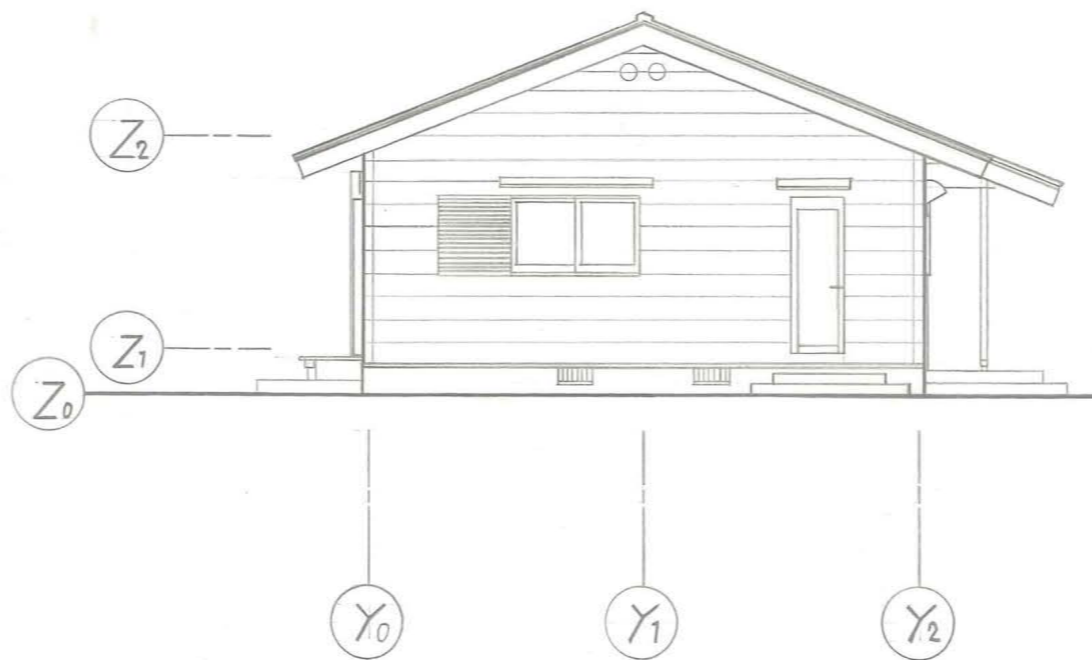

東立面図

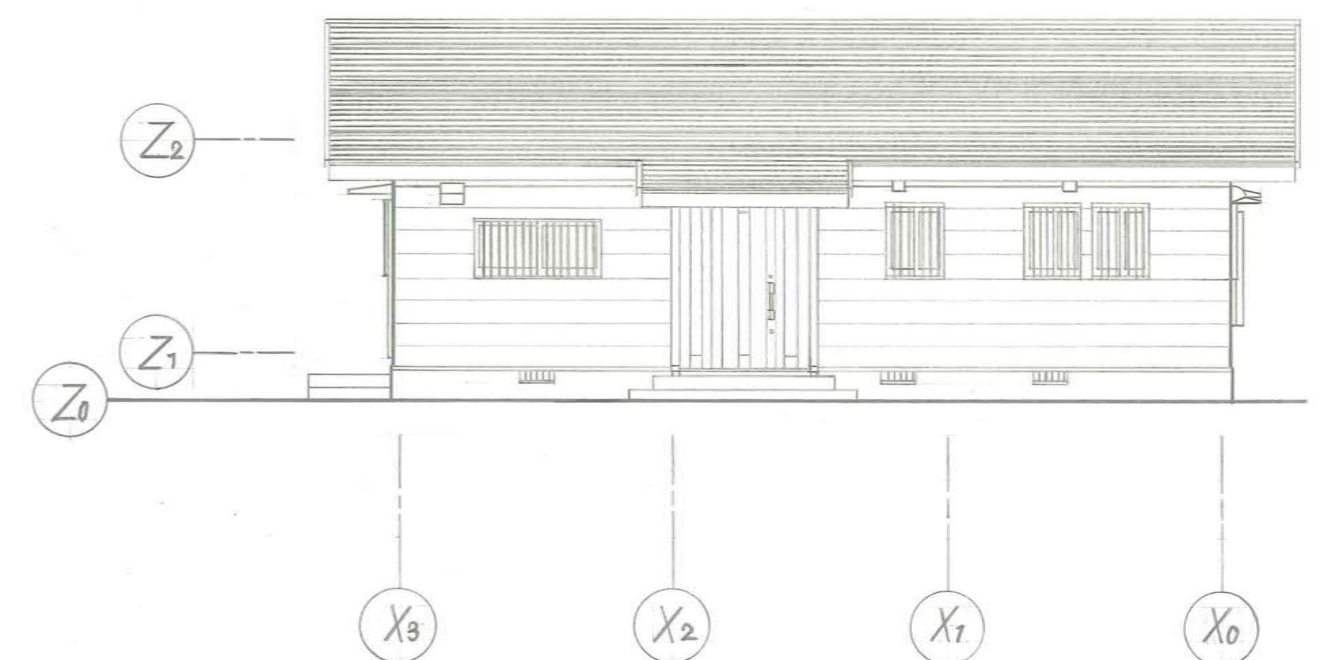

北立面図

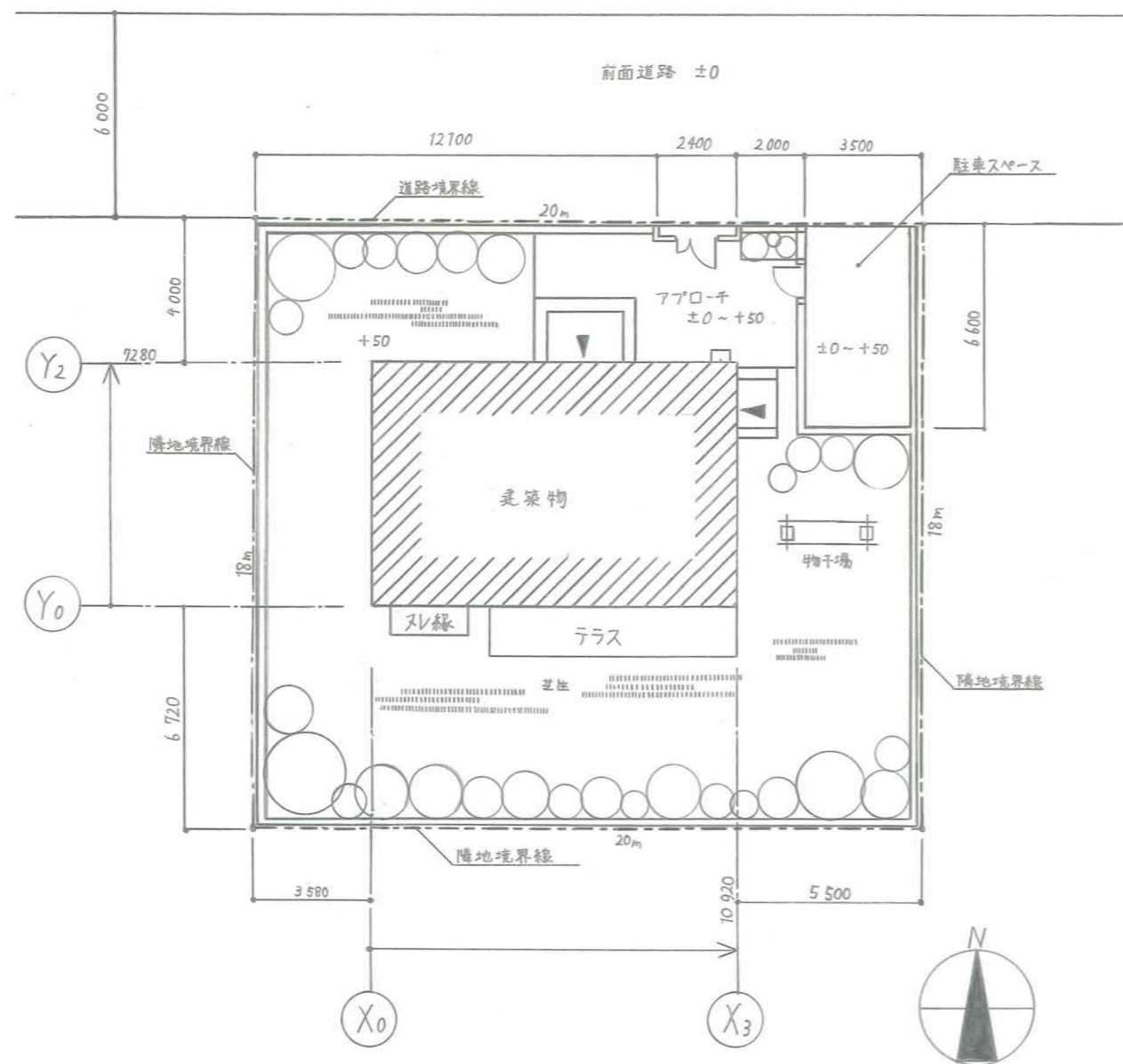

配置図 1:200

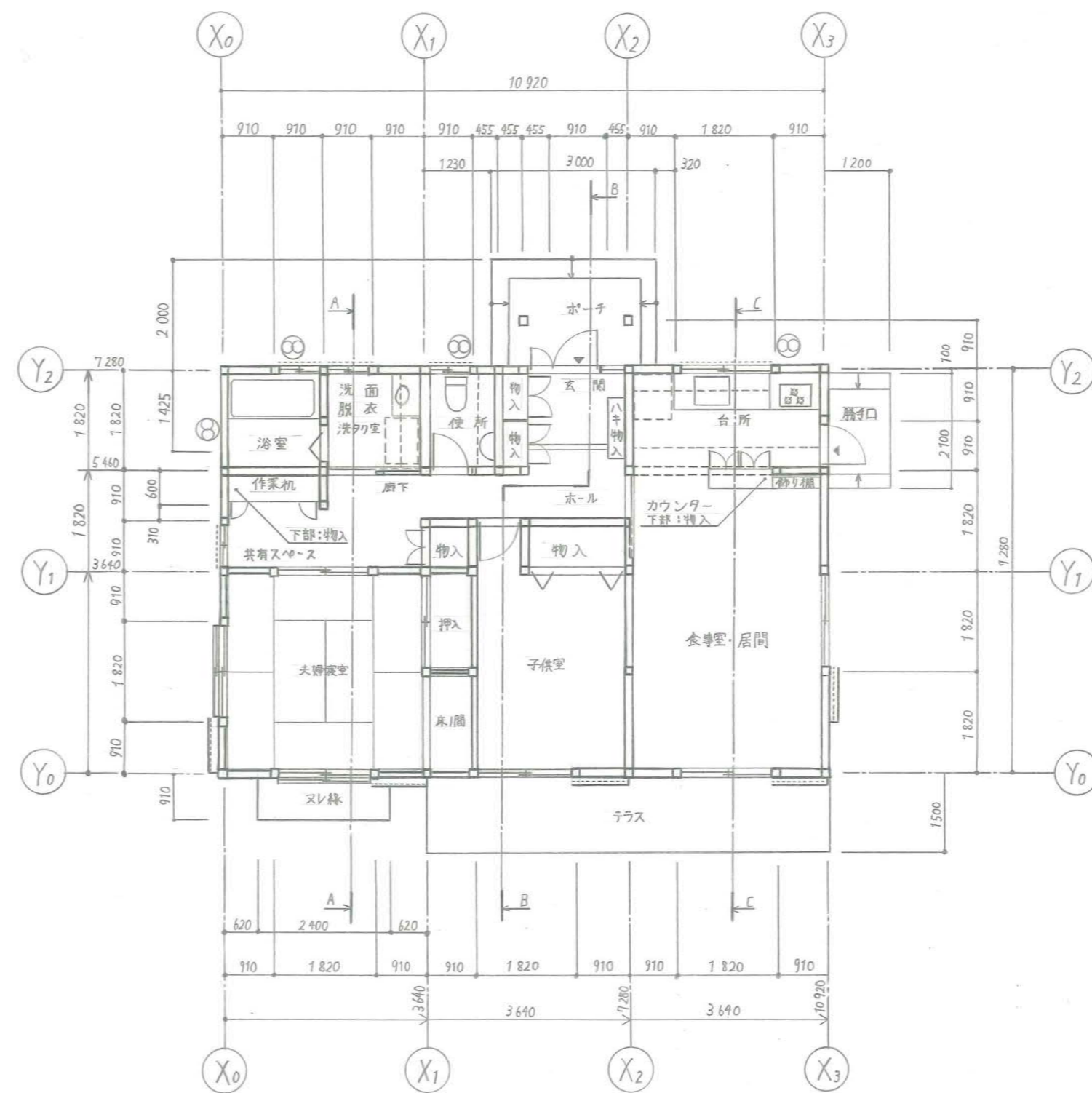

平面図 1:100

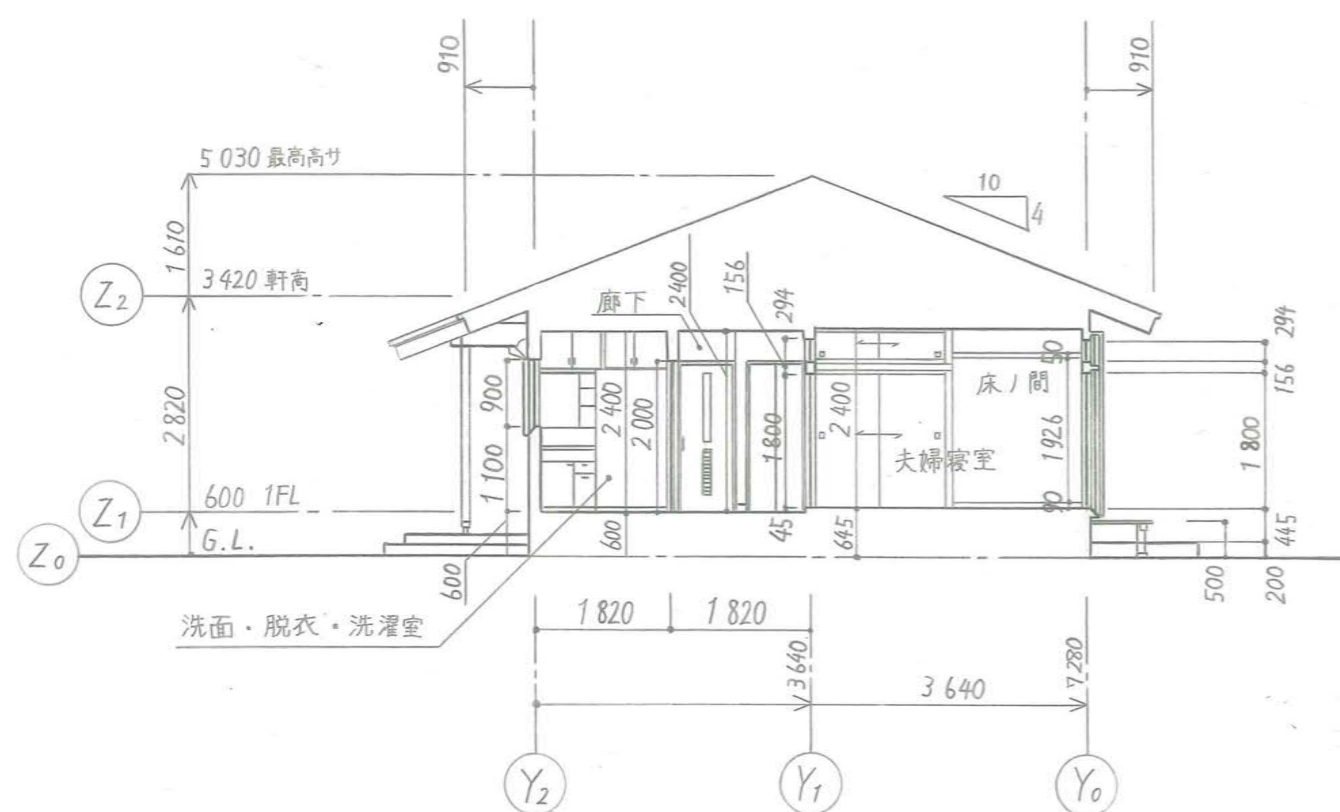

A-A断面図

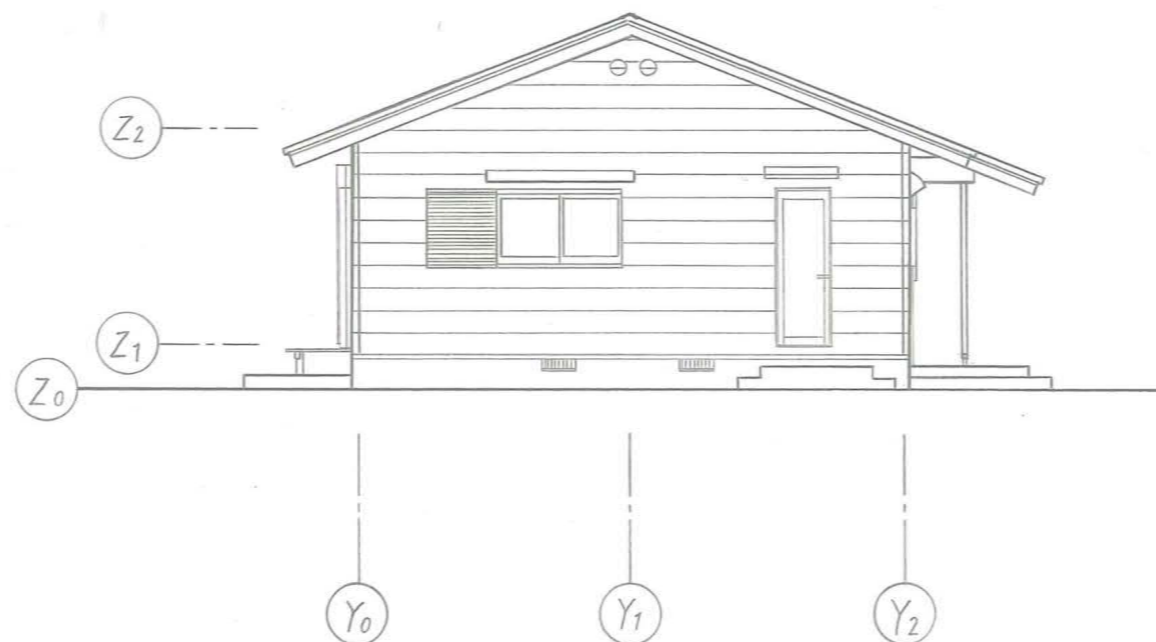

東立面図



北立面図

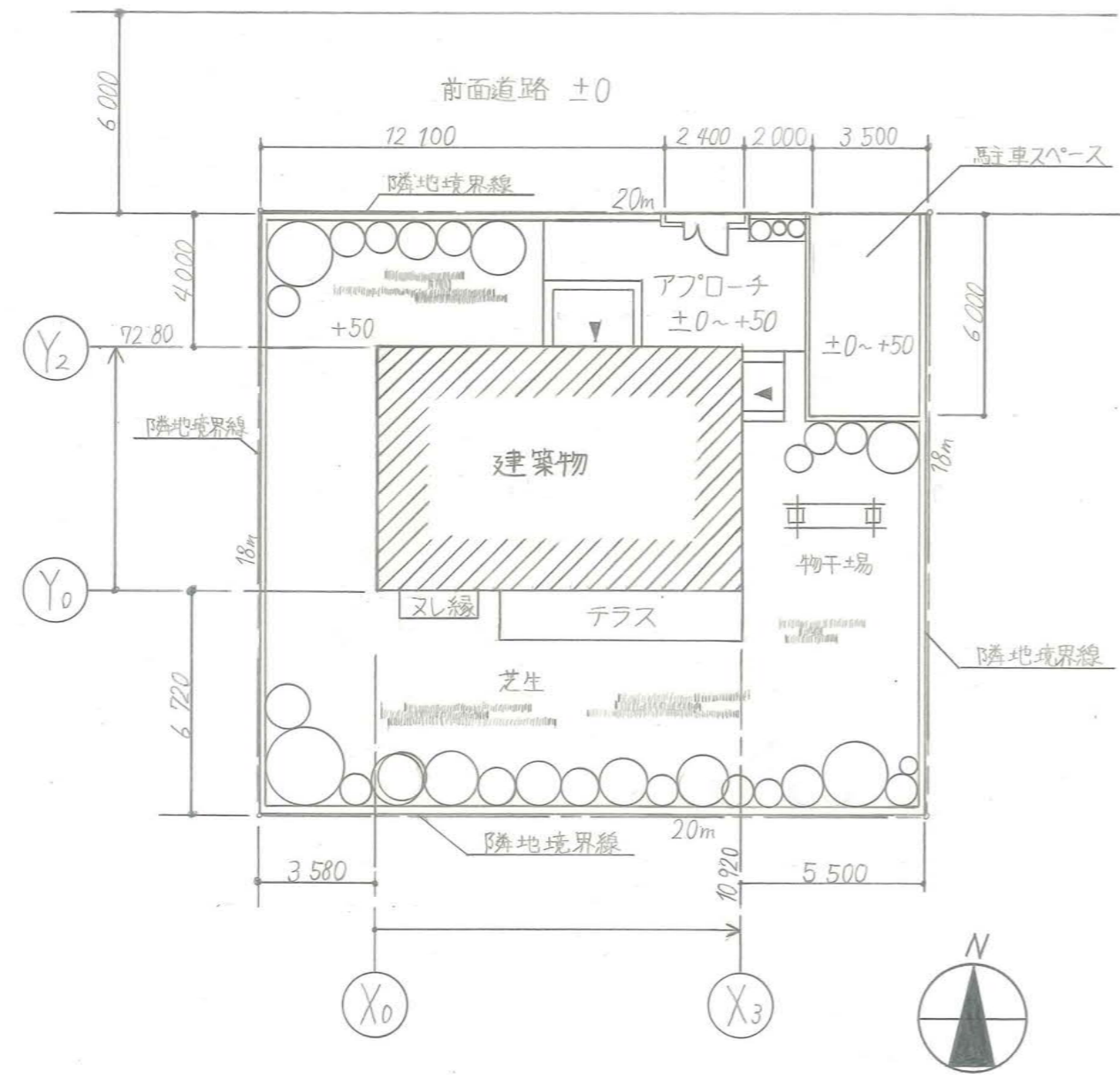

配置図 1:200

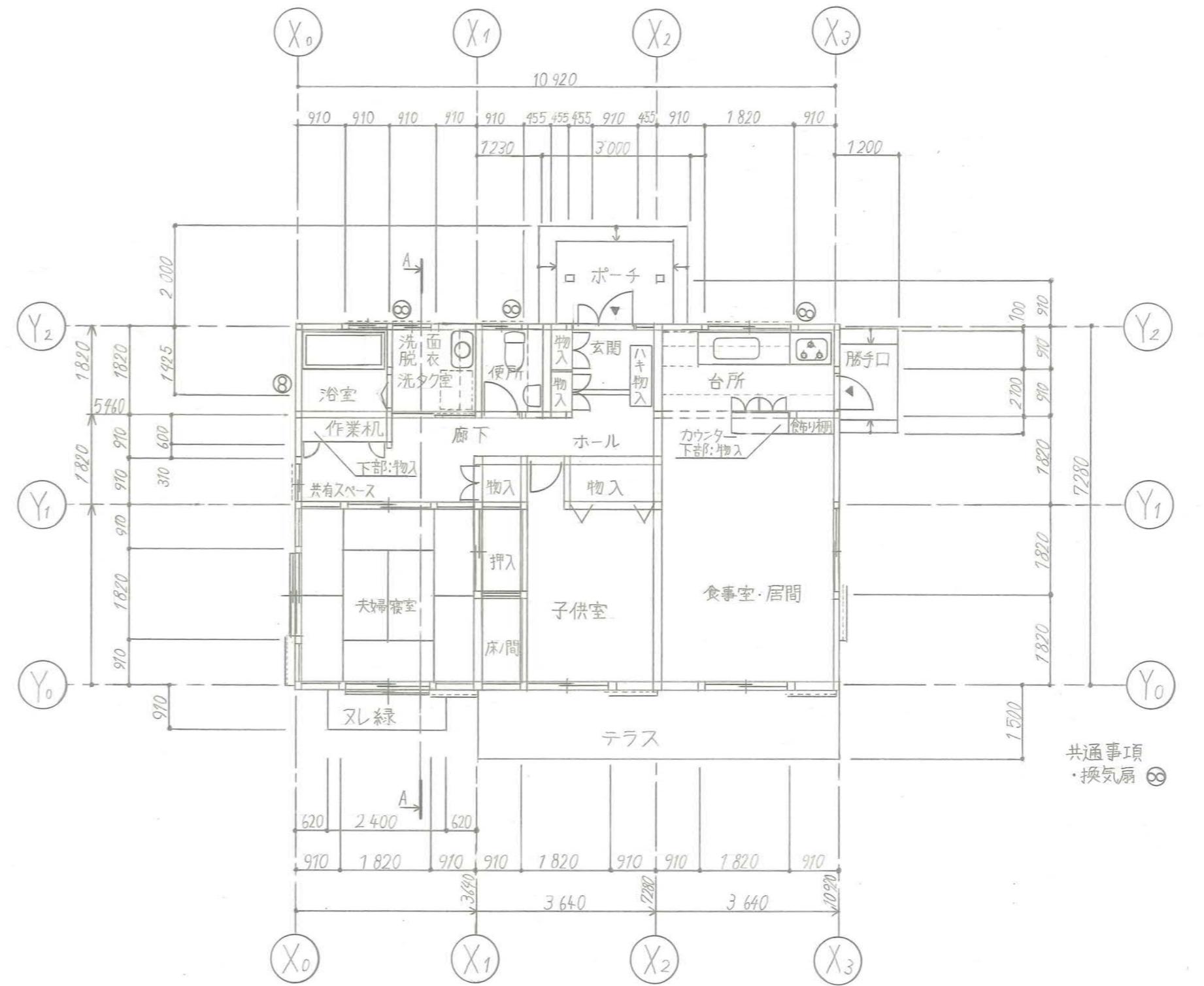

平面図 1:100

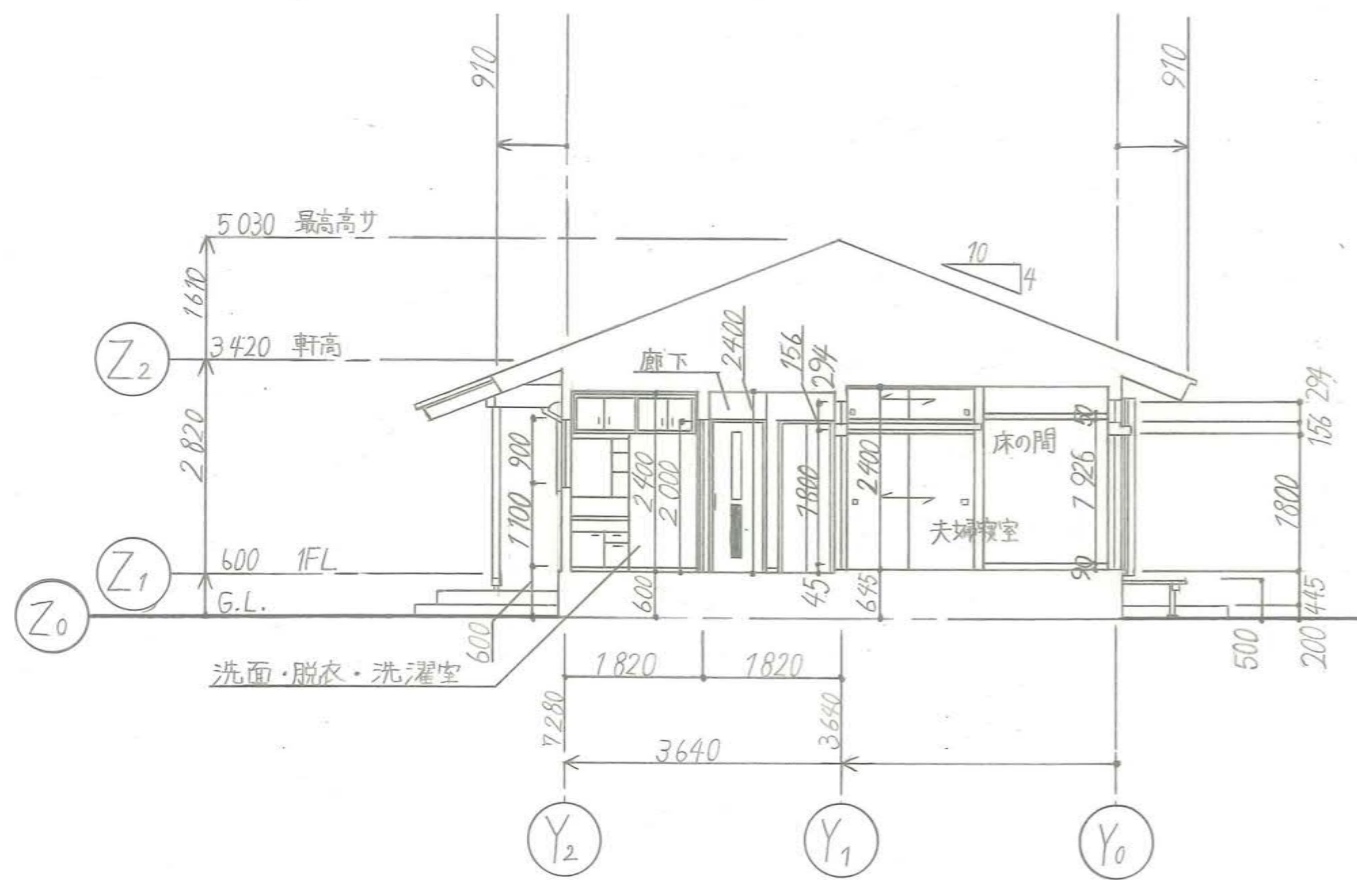

A-A断面図

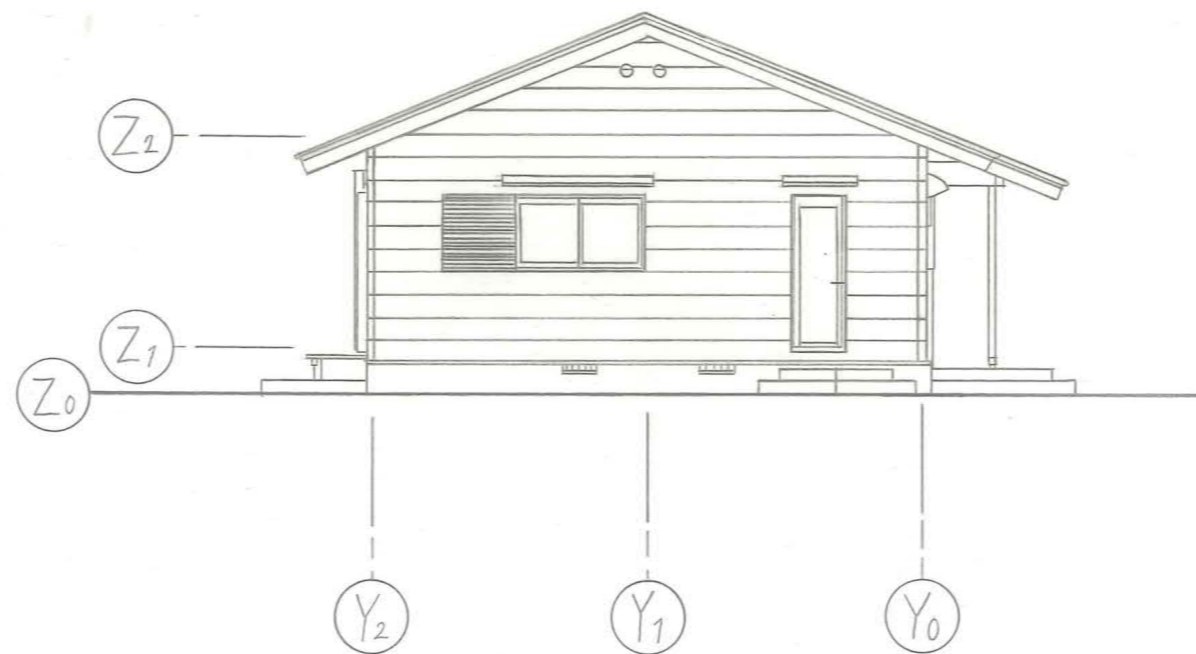

東立面図



北立面図

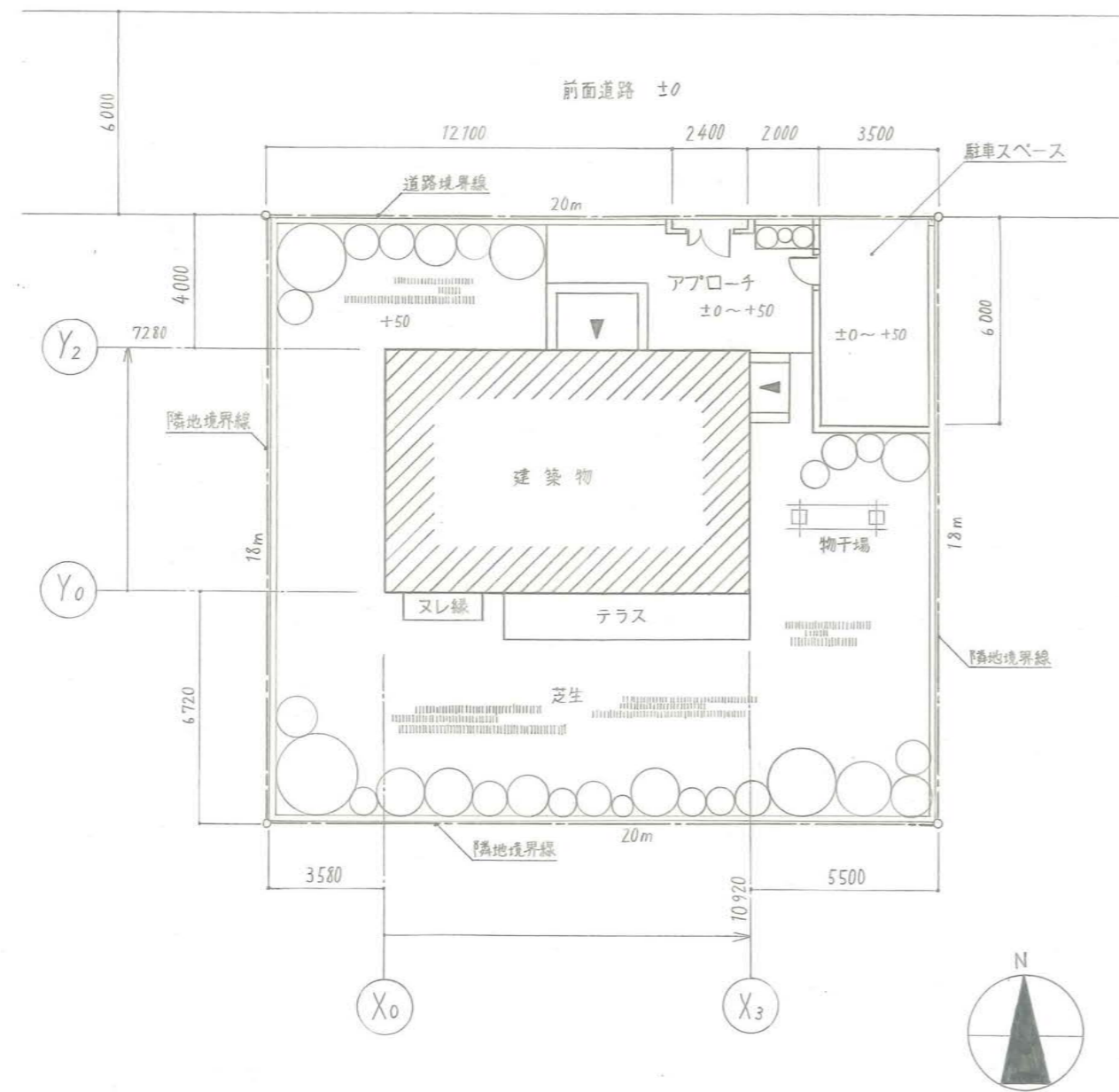

配置図 1:100

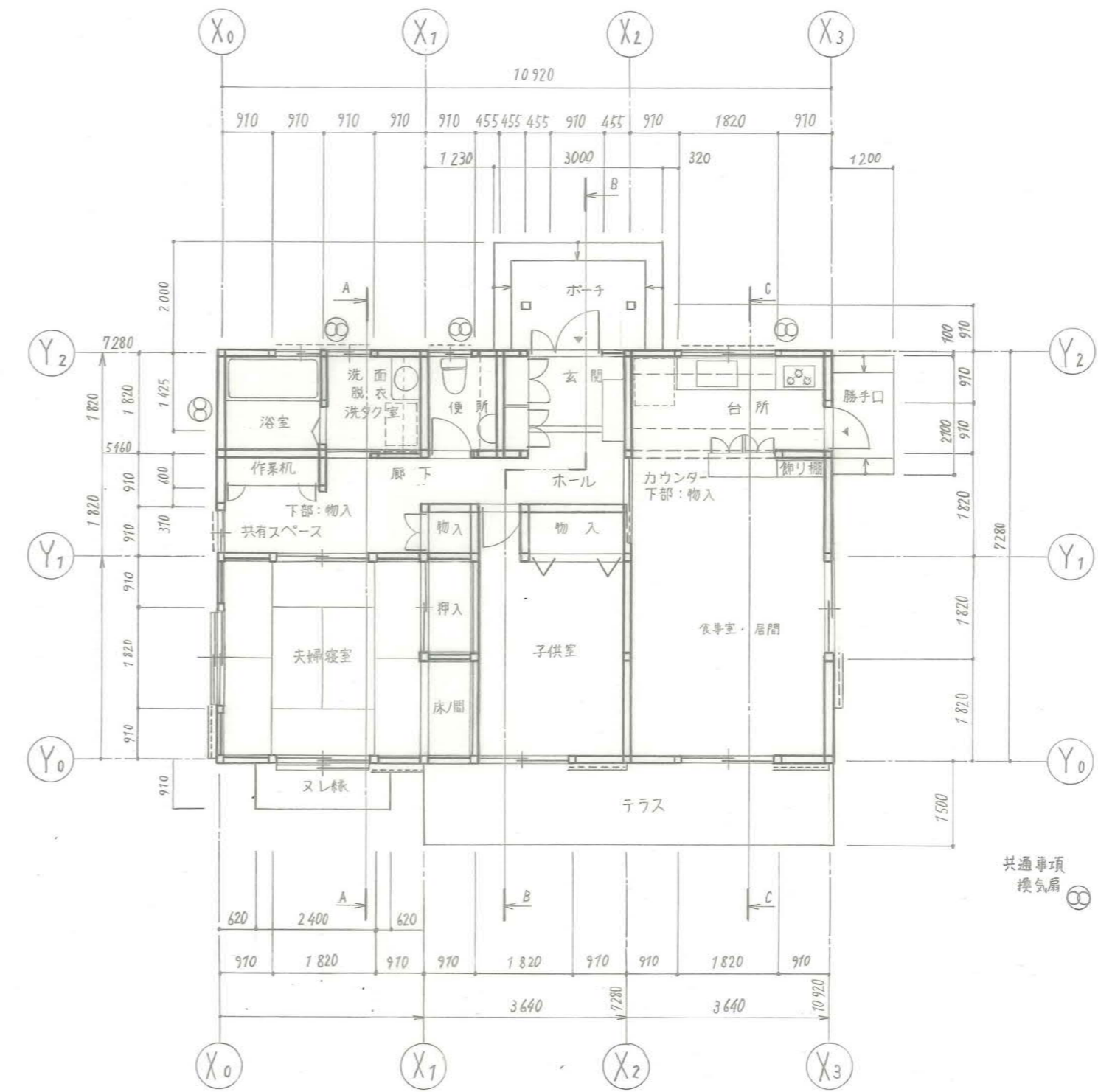

平面図 1:100

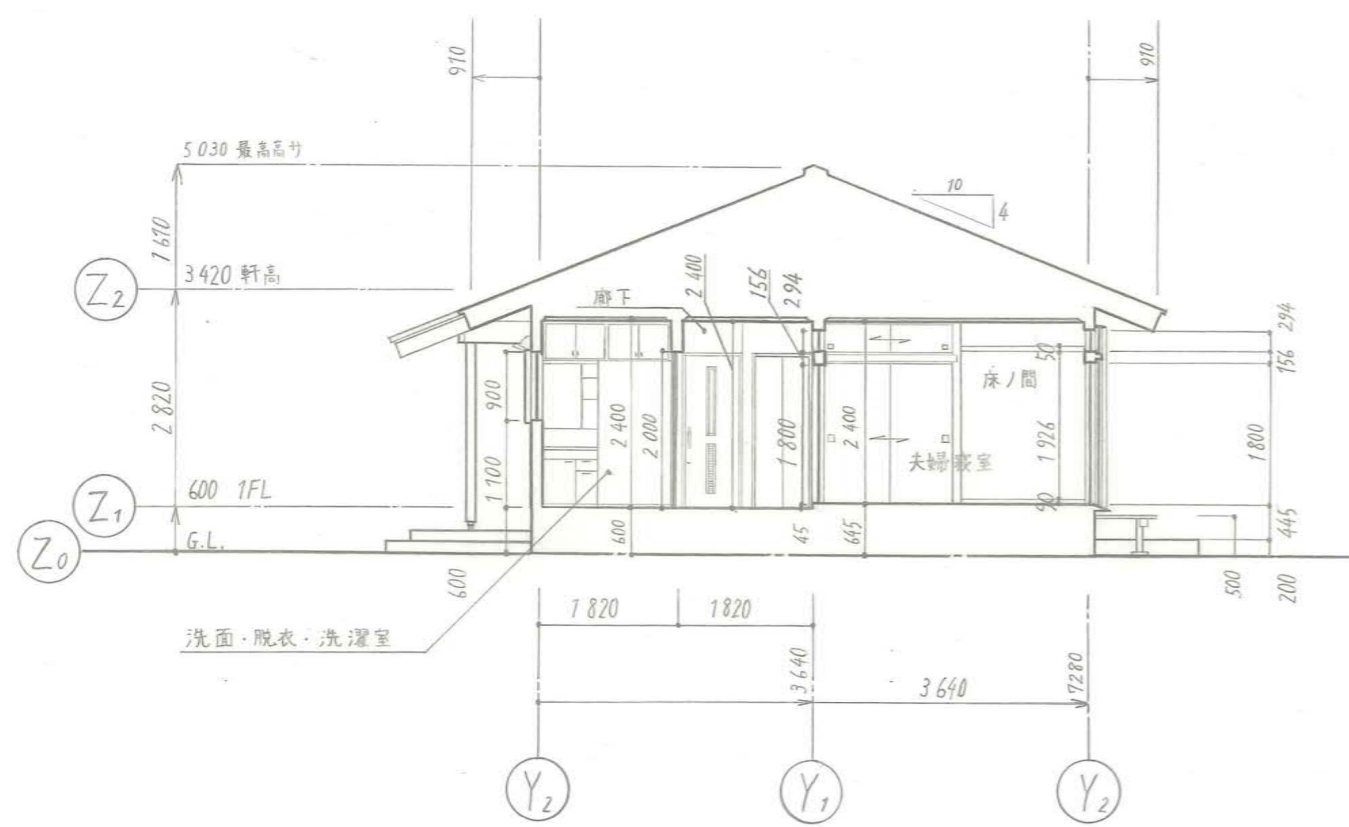

A-A断面図

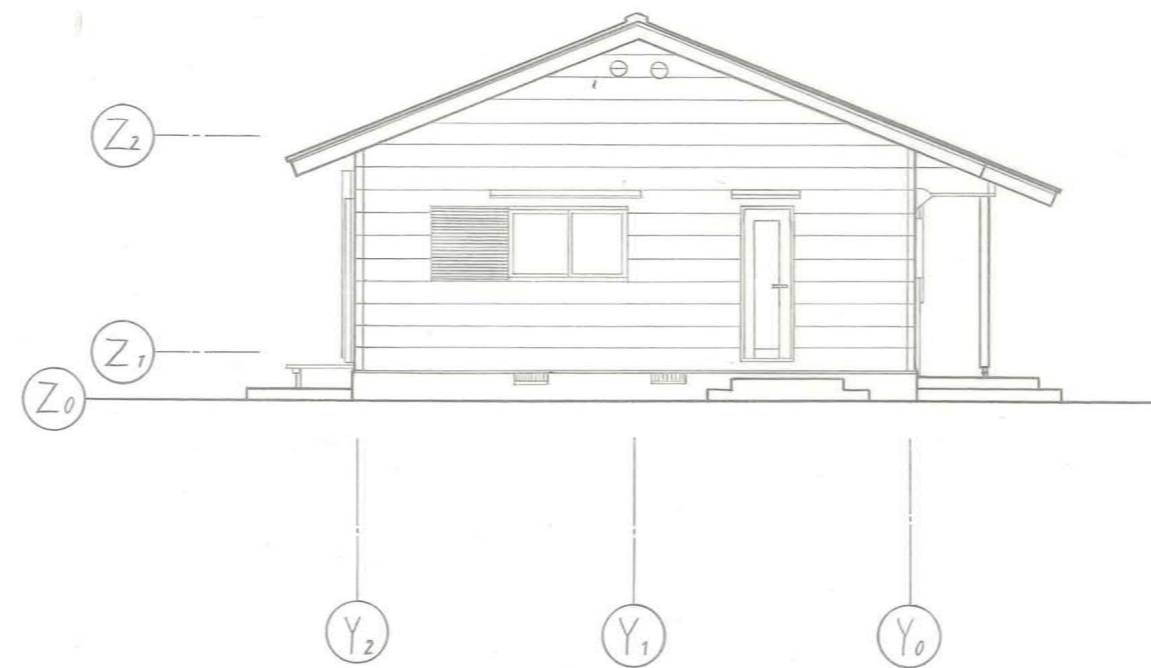

東立面図

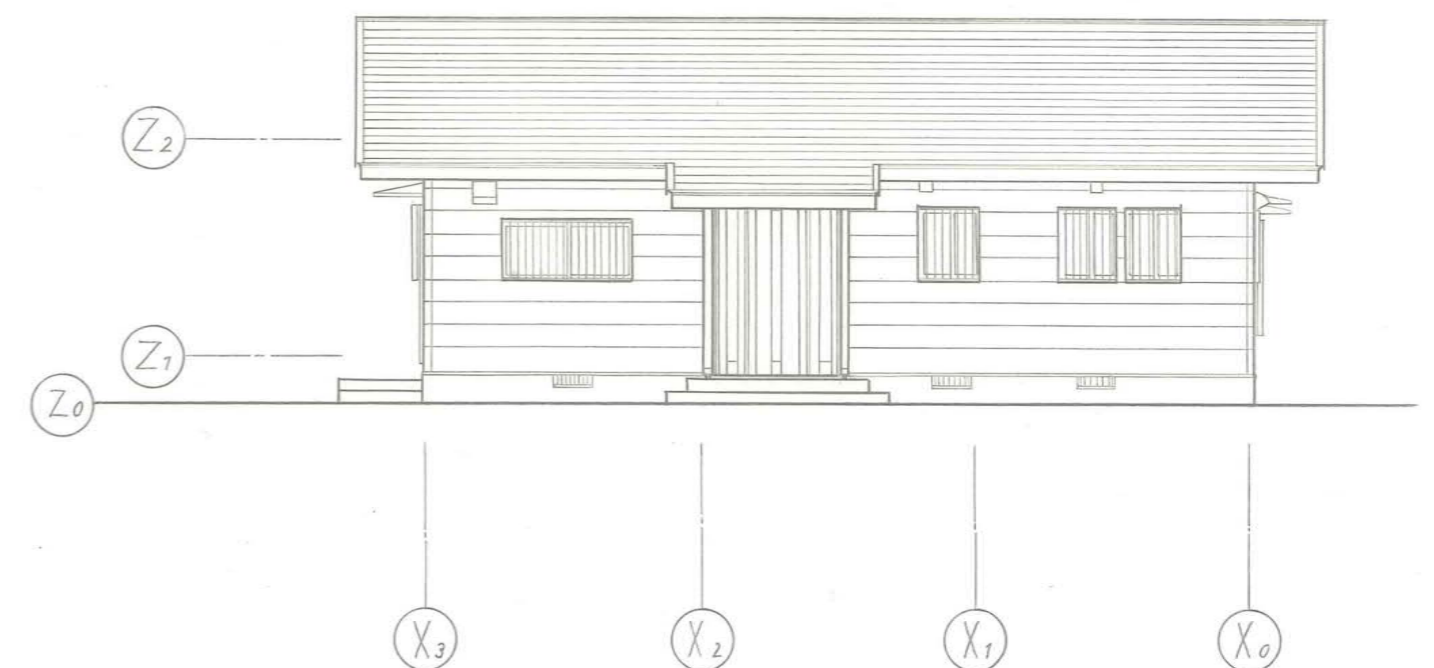

北立面図

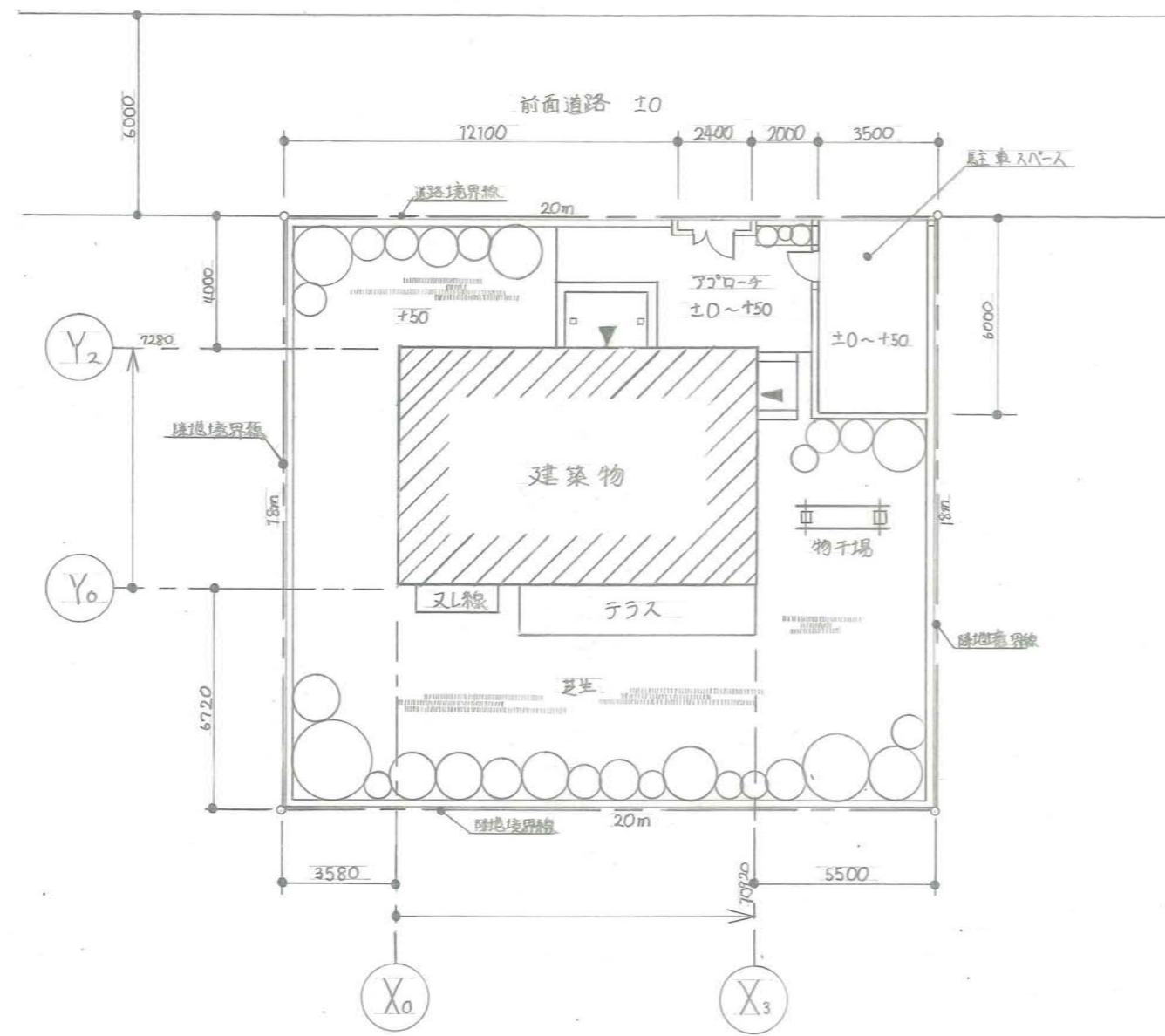

配置図 1:200

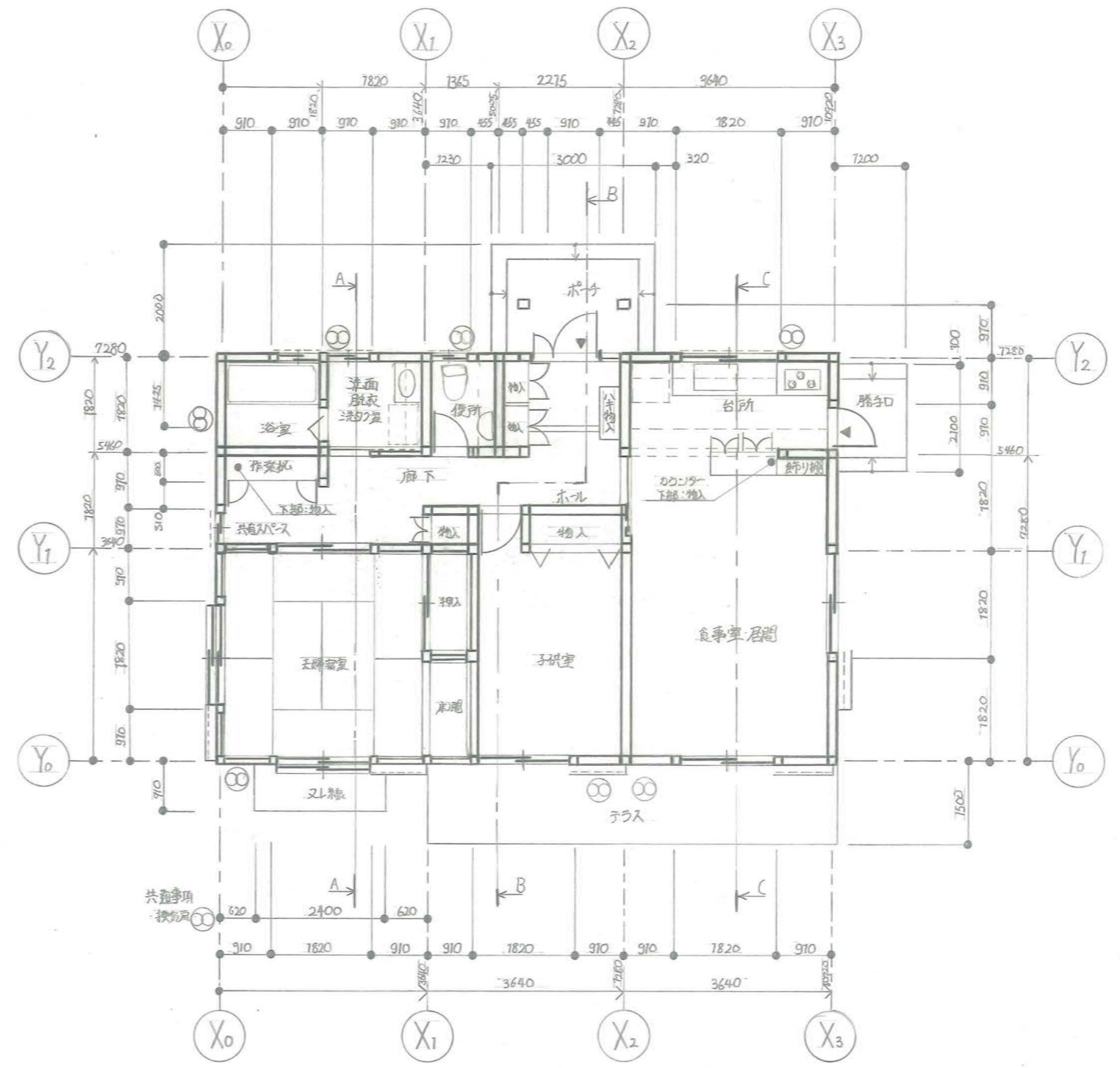

平面図 1:100

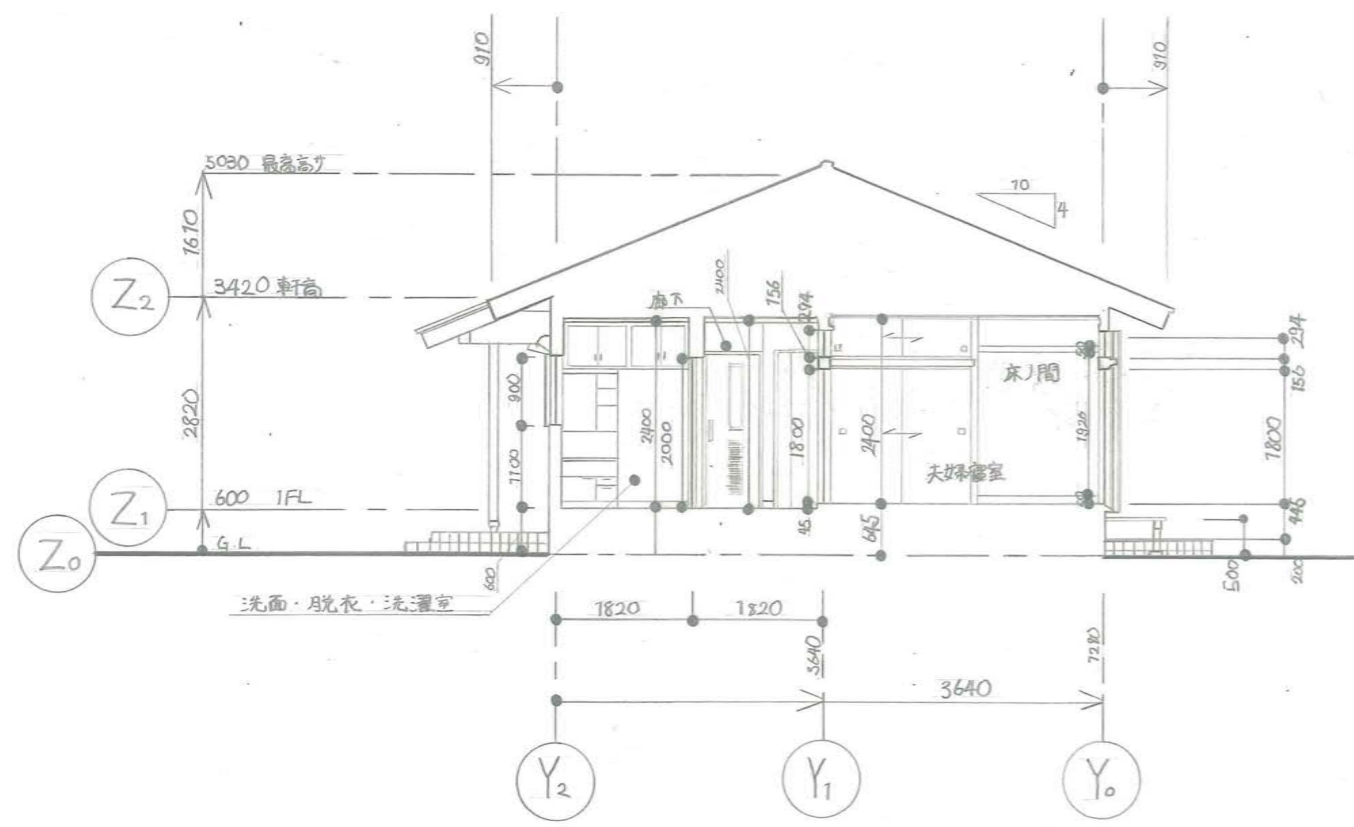

A-A断面図 1:100

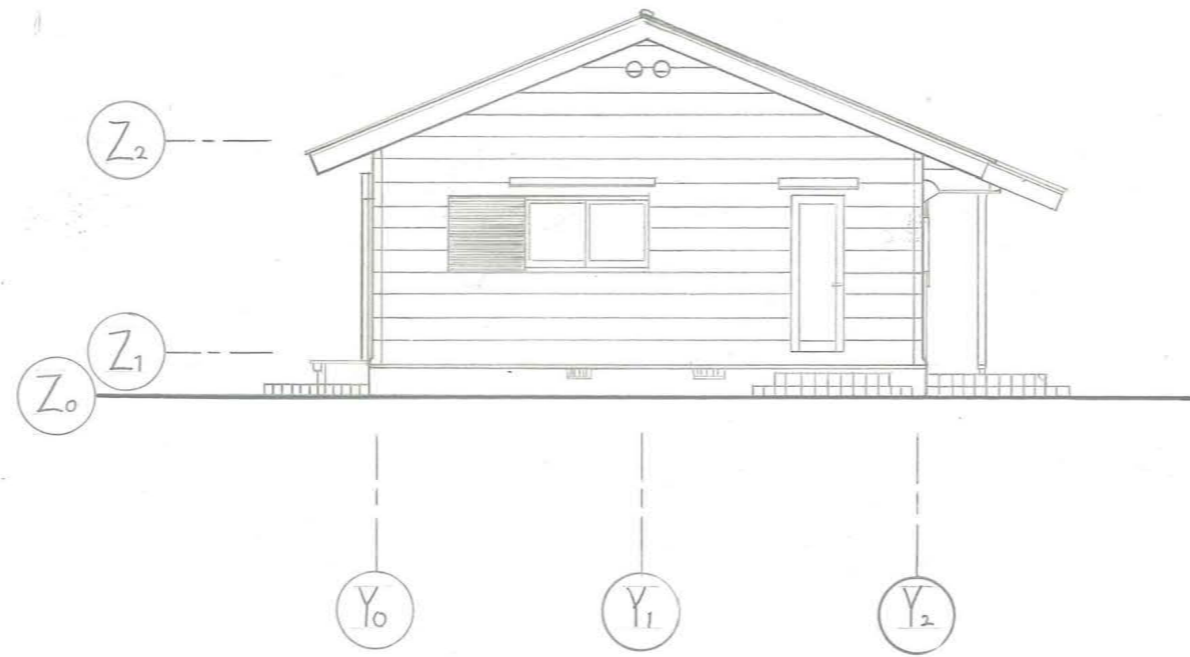

東立面図 1:100



北立面図 1:100

